

FROZEN FOOD

RLTM

GLASS DOOR FREEZER



ENHANCED ENERGY EFFICIENCY
& VERSATILITY

HUSMANN®

PRODUCT BENEFITS

- Ergonomic design for easy access
- Alternative shelving layouts to optimise merchandising
- Optimised display with LED lighting
- Energy efficient door solution
- Low Total Energy Consumption (TEC)
- Product temperature compliance
- Simple to install and maintain

STANDARD FEATURES

- Internal and external powder coating
- Vertical 4000K mullion LED lights
- 6 rows of 660mm solid powder coated unlit shelves
- Ticket strips
- Base wire tray
- Wire air return grill
- Rubber bumper
- Galvanised base
- Evaporator assembly fitted with valve
- Copper evaporator coil
- EC fan motors
- Digital thermometer display fitted
- Draw wire in conduit

CUSTOMISATIONS

Shelving & Base Shelf

- Optional additional shelves and brackets
- Wire shelf and wire basket
- Product dividers
- Base basket dividers
- Wire shelf fences 75mm

Ends

- Solid end with powder coated trim
- Glass view end with powder coated trim
- Acrylic full height system divider

Bumper

- Stainless steel bumper (single rail)

Other

- Anti fog film applied to door
- Rear dress panel
- Rear vent kit
- Top mount piping
- Valance panel
- Hot gas defrost
- Option for medium temperature operation
- Technology solutions
- Electronic shelf labels or video rail

Energy & Sustainability

- Anti sweat icon controller

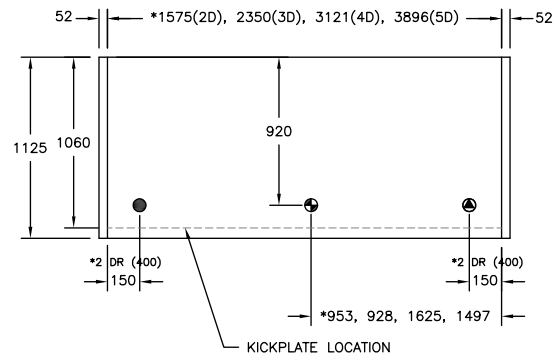
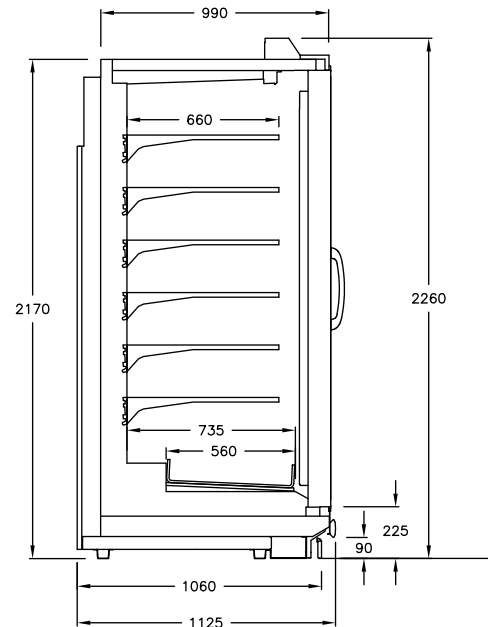

AVAILABLE LENGTHS





Excluding Ends: 1575, 2350, 3121, 3896

TEMPERATURE CLASS
3L1

(-18 °C to -15 °C)

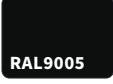
AVAILABLE DEPTHS

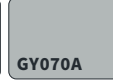
RLN - Narrow: 1010
 RL - Standard: 1110
 RLTM - Tall: 1130

AVAILABLE COLOURS

 RAL9005	 GN150A	 GL180A	 GY070A	 MW201T	 GL205A
 RAL9003	 RAL9010				

Additional Information

All Dimensions shown in Millimetres (mm) unless otherwise stated. Dimensions and features are subject to change. Please obtain current technical information prior to order confirmation.

NOTE: We reserve the right to change or revise specifications and product design in connection with any feature of our products. Such changes do not entitle the buyer to corresponding changes, improvements, additions or replacements for equipment previously sold or Shipped.

