

Outdoor Type Refrigeration Unit (Non-fluorocarbon Refrigeration Unit with CO₂ Refrigerant)

Operating Instructions and Installation Instructions

Model No. OCU-CR200VF5 / OCU-CR200VF5SL

Thank you very much for purchasing Panasonic products this time.
Please read this instruction booklet and correctly comply with the explanations.
In particular, please read "Cautions for Safety" (Pages EN2 to EN8) for ensuring safe operations.
Please retain this instruction booklet in a safe place.



CONTENTS

Cautions for Safety	2-8
Name of Each Part	9
Scope of Application, Specifications	10-11
For Effectively Using the Refrigeration Unit	12-13
Selection of Installation Location	13-14
Carry-in/Installation.	14-15
Installation Example	16-17
Refrigerant Piping Work	17-18
Piping Example.	19
Refrigerant Circuit Diagram	20
Refrigerant Charging	21-22
Cautions for Electrical Wiring Work	23
Electrical Wiring Work	24-25
Electrical Circuit Diagram	26-27
What Needs to be Checked before Operation	28
Setting and Indication	29-33
Control Functions	34-36
Adjustment during Operation	36-38
About Alarms	38-39
Maintenance and Inspection	40
Actions at the time of Failure	41-42
Failure Diagnosis	43-50

Caution labels are attached to the product.

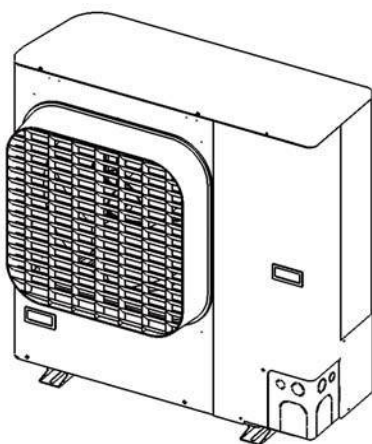

This illustration represents OCU-CR200VF5

NOTICE

- The English text is the original instructions. Other languages are translation of the original instructions.





Cautions for Safety



(Be sure to comply with the following)

For the purpose of avoiding harm to people and damage to properties, items to be complied with are explained here.

- Explanations are classified by degree of harm or damage caused by incorrect use.





 WARNING	Indicates possibility of death or serious injury.
 CAUTION	Indicates possibility of minor injury or damage to properties.

- Items to be observed are explained by the following pictograms.

	Indicates what you should not do.
	Indicates what you must do.

WARNING





Installation Work

<p>Installation to be made by manufacturer's service personnel or similarly skilled person.</p> <p> Incorrect installation work may lead to malfunction such as abnormal vibration, and generates refrigerant gas leak, electrical shock, or fire.</p>	<p>Do not use other than the designated refrigerant (for charging, adding or recharging)</p> <p> Non-designated refrigerant may cause equipment failure or burst, or injury.</p>
<p>Appliances employing R-744 refrigeration system.</p> <p> System contains refrigerant under high pressure. Do not tamper with the system. It must be serviced by qualified persons only.</p>	<p>Securely complete refrigerant piping before carrying out airtight testing.</p> <p> Refrigerant gas leak may cause suffocation.</p>





Cautions for Safety

(Be sure to comply with the following)

Installation Work

<p>Installation should be made securely on a place that can fully support the mass of the refrigeration unit.</p> <p> Insufficient foundation may cause falling or dropping, and lead to refrigerant gas leak, injury, electrical shock, or fire,</p> <ul style="list-style-type: none"> • Refrigeration unit should be secured on a concrete base with a mass approximately 3 times that of the unit and fastened with anchor bolts. 	<p>Perform airtight test before charging refrigerant.</p> <p> Refrigerant gas leak may cause insufficient oxygen and lead to a death accident.</p> <ul style="list-style-type: none"> • Carry out airtight test and confirm no leak of refrigerant.
<p>Install the safety cover.</p> <p> Touching the refrigeration unit by hand of the people other than the designated operators may cause injury.</p> <ul style="list-style-type: none"> • Install a safety cover or protective fence. 	<p>Piping, equipment components and tools should be exclusively for R744 (CO₂ refrigerant).</p> <p> Use of components for HFC refrigerant may cause serious accidents such as equipment failure and rupture of the refrigerant cycle.</p>

Electrical Work

<p>Always use a dedicated circuit and install a ground fault protector.</p> <p> Incorrect electrical work may lead to current leak and fire or electrical shock.</p> <ul style="list-style-type: none"> • Wiring work should conform to the installation instructions. 	<p>Grounding Work</p> <p> Lack of grounding work may lead to electrical shock caused by current leak.</p> <ul style="list-style-type: none"> • Securely carry out grounding work by qualified technicians.
<p>Electrical wiring should use the specified cable and to be properly secured.</p> <p> When the specified cable is not used, or connection or securing is incomplete, electrical resistance becomes larger and may cause abnormal heating or fire.</p> <ul style="list-style-type: none"> • Use the specified cable and properly secure it on an appropriate location. 	<p>Securely place the cover on the electrical box and enclosure panel.</p> <p> Incomplete attachment may lead to penetration of water and living creatures, thereby causing current leak and fire/electrical shock.</p> <ul style="list-style-type: none"> • Confirm that covers are securely installed.

Cautions for Safety

(Be sure to comply with the following)

Cautions for Use

Do not change the set values of the safety device.



Using the refrigeration unit with changed values may cause failure of the safety stop function and lead to a burst or fire.

- Do not change the set values of the safety device. If they are changed unintentionally, shut off the power switch and ground fault protector and consult with the distributor.

Do not insert a finger, stick or foreign object into the ventilation opening and fan guard of the enclosure panel.



Such object may hit the fast rotating fan and result in injury.

When water or other material gets into the electrical box, turn off the power switch and shut off the ground fault protector.



Continued use may cause short-circuit, leading to fire or electrical shock.

- Do not splash water on electrical components or wash them with water.

When the ground fault protector activates, report to the specialty company.



Forced recovery of power may cause current leak, leading to fire or electrical shock.

For the purpose of controlling concentration of refrigerant gas, install a leak detector and mechanical ventilation equipment in the refrigerant-handling facility (inside the room).



Refrigerant gas leak may cause suffocation.

Restriction on use of equipment



The appliance is not to be used by persons (including children) with reduced physical, sensory or mental capabilities, or lack of experience and knowledge, unless they have been given supervision or instruction.

Consideration for children



Children being supervised not to play with the appliance.

Restriction on use of equipment



This appliance can be used by children aged from 8 years and above and persons with reduced physical, sensory or mental capabilities or lack of experience and knowledge if they have been given supervision or instruction concerning use of the appliance in a safe way and understand the hazards involved.

Consideration for children



Children shall not play with the appliance.

«In the European Market»

Cleaning and maintenance by trained person.



Cleaning and user maintenance shall not be made by children without supervision.





«In the European Market»

«In the European Market»

Cautions for Safety

(Be sure to comply with the following)

Repairs

<p>Disassembly or repairs should be performed by a specialty operator.</p>  <p>Incorrect disassembly or repair may lead to abnormal operation and causes injury, fire or electrical shock.</p> <ul style="list-style-type: none"> Request a specialty operator to perform disassembly or repair work. <p>Do not absolutely perform modification.</p>	<p>When abnormal operation was detected, or before starting disassembly or repair, turn off the power switch and shut off the ground fault protector.</p>  <p>Continued operation with abnormal condition, or disassembly/repair without shutting off the power would lead to current leak or short-circuit and may cause fire or electrical shock.</p>
<p>Specified components must be used for repair.</p>  <p>Use of non-specified components may cause failure of the safety stop function and lead to burst or fire.</p> <ul style="list-style-type: none"> Consult with the distributor. 	<p>Stop the compressor before disconnecting the refrigerant piping.</p>  <p>Disconnecting the piping while the compressor is in operation would cause abnormally high pressure with air intake, and may lead to a burst or injury.</p>
<p>Replacing the power cord.</p>  <p>If the supply cord is damaged, it must be replaced by manufacturer, its service agent or similarly qualified persons in order to avoid a hazard.</p>	

Moving or Change of Installation Location

<p>Request a certified installer for moving or changing the location.</p>  <p>Incorrect installation or moving work may lead to malfunction such as abnormal vibration, and generates refrigerant gas leak, electrical shock, or fire.</p>	
-------------------------------------------------------------------------------------------------------------------------------------------------------------------------------------------------------------------------------------------------------------------------------------------------------------------------------	--

Cautions for Safety

(Be sure to comply with the following)

CAUTION

Installation Work

Do not install in a place with possible leak of flammable gas.



Leaked flammable gas around the refrigeration unit may catch fire from a spark of a switch and lead to fire.

Produce a refrigeration cycle within the limits of an operation standard (Scope of Application).



Non-standard refrigeration cycle may generate abnormal high pressure and abnormal heat generation, thereby causing burst, smoke generation, fire and current leak.

Apply a drain work according to the need.



Without consideration of drain water processing, moisture from rainwater and defrosted water generates mold and moss, and may cause slipping on the floor.

Apply heat insulation on the suction line and liquid line.



Lack of heat insulation generates water from condensation and mold and moss, thus causing slipping on the floor.

Install in a place without air stagnation.



Leak of refrigerant gas may cause insufficient oxygen and harm human health.

- Install in a place with good ventilation.

Request a specialty operator for moving the refrigeration unit.



Incorrect moving may cause falling or dropping of the refrigeration unit, and cause injury.

- Refrigeration unit is a heavy item. Always consult with a specialty operator.

Electrical Work

Always install a ground fault protector with the specified capacity.



Incorrect capacity does not operate safety stop function and may lead to fire or electrical shock.

Ground fault protector needs to follow IEC60364-4-44 443, overvoltage category III. (Impulse withstand voltage value 4kV.)

Do not include electrical wiring in the heat insulation material.











Condensation of piping may cause current leak and fire caused by overheating.

Cautions for Safety

(Be sure to comply with the following)

Cautions for Use

<p>When the refrigerant bursts out, shut off the power and fully close the service valve.</p> <p> Blowout of refrigerant from the refrigeration cycle by opening the service port would cause insufficient oxygen and harm human health.</p>	<p>Do not use flammable spray near the refrigeration unit. Do not place flammable materials nearby.</p> <p> Flammable material may catch fire from switch spark.</p>
<p>Do not touch electrical components by a wet hand.</p> <p> Switching operation by a wet hand may cause electrical shock and injury.</p>	<p>Before any inspection service, turn off the power switch and shut down the ground fault protector.</p> <p> Inspection work with power on may lead to electrical shock, interference with the moving mechanism, and heat generation, thereby leading to injury and skin burn.</p>
<p>Periodically check operation of the ground fault protector.</p> <p> Failed interrupter does not operate safety stop function and may lead to fire or electrical shock.</p>	<p>When removing the fin guard of the gas cooler, do not touch the fin.</p> <p> Touching the fin and sliding along the fin may cause skin cut by the fin edge.</p>
<p>Do not ride on the refrigeration unit.</p> <p> Riding on the refrigeration unit or placing an article on it may lead to falling or dropping by vibration and cause injury.</p>	<p>Do not operate with the service valve closed.</p> <p> Operation with the high pressure service valve closed would cause abnormal high pressure and may lead to a burst.</p>
<p>Periodically check the installed base.</p> <p> Damaged base after a long-time use may cause the refrigeration unit to fall or drop and lead to injury.</p>	

Cautions for Safety

(Be sure to comply with the following)

Disposal

Request a specialty operator for disposing the refrigeration unit.



The refrigeration system is under high pressure. Disposal with the refrigerant and oil inside the refrigeration unit may cause fire or explosion.

Before disposal



The refrigeration system is under high pressure. Do not tamper with it. Contact qualified service personal before disposal.

Name of Each Part

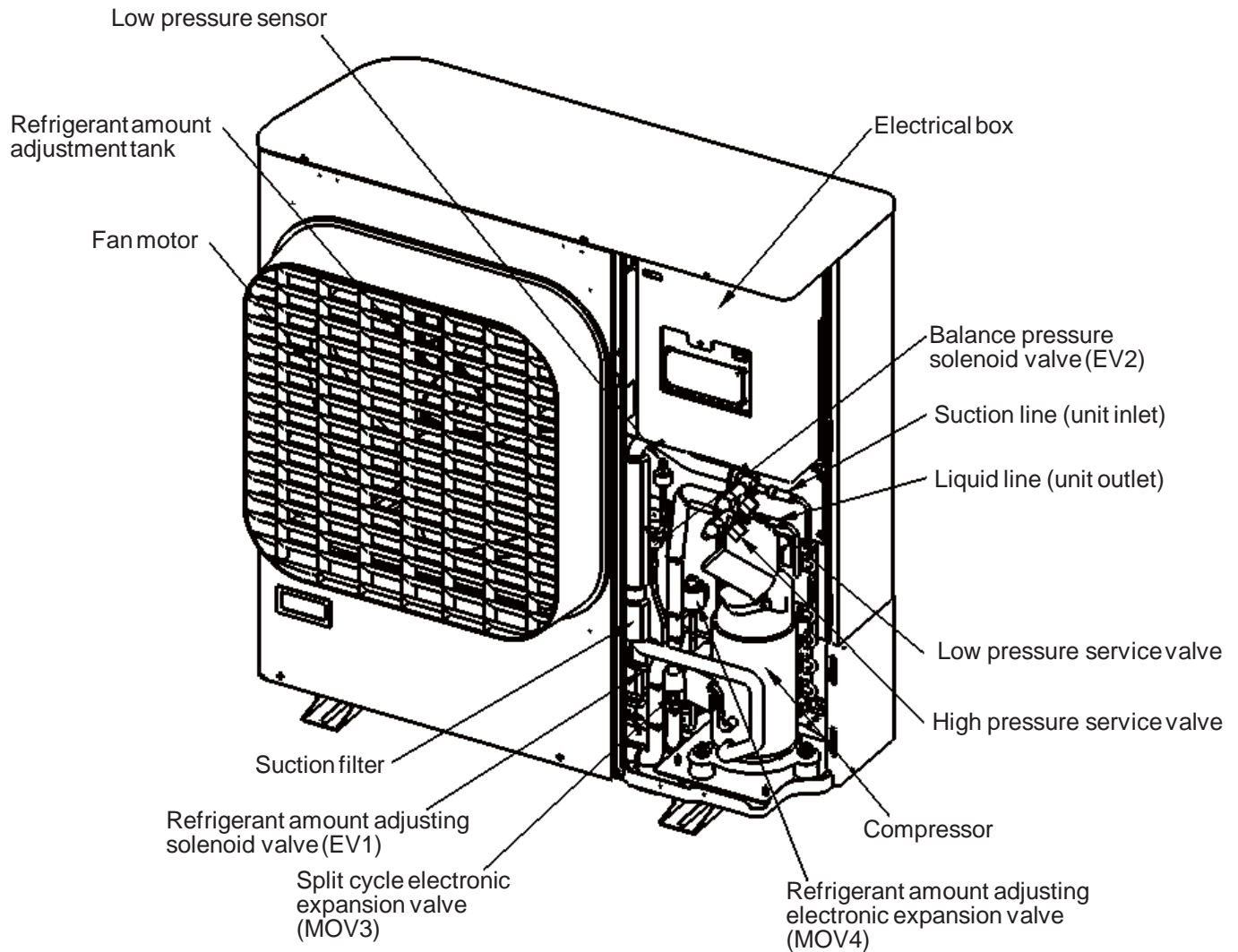

ENGLISH

Electrical box internal layout

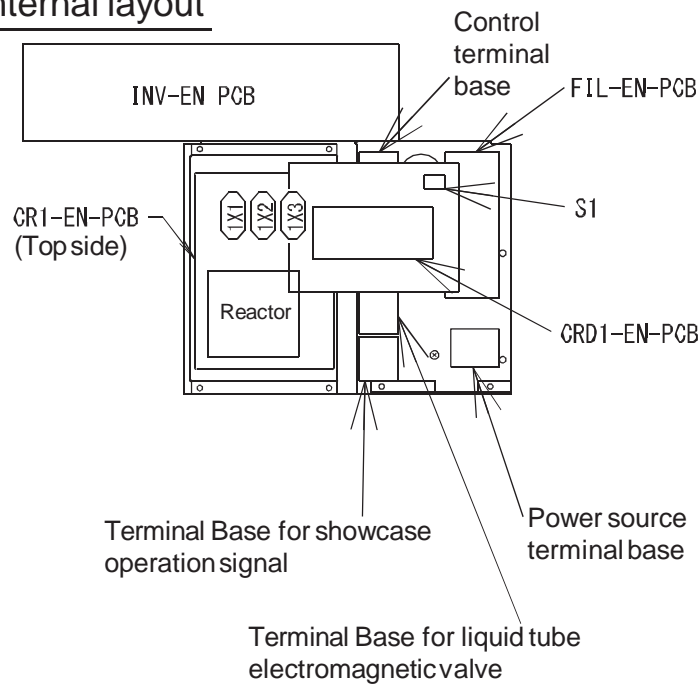

Scope of Application, Specifications

This refrigeration unit operates with a rotary compressor.

Use the refrigeration unit within the range shown below.

Item	Standard Value	Remarks
Refrigerant	R744	The charge supply amount shall be adequate
Evaporating temperature	-45 °C to -5 °C	Temperature conversion of inlet pressure
Suction pressure	0.73MPa to 2.95MPa	Unit inlet pressure
Compressor rotational speed	37 s ⁻¹ to 65 s ⁻¹	* (RPS)
Suction gas temperature	18 °C or below	Unit inlet (suction gas) pipe temperature
Superheat at suction	10 K or above	Difference between evaporating temperature and compressor inlet temperature
Discharge pressure	9.0MPa or below (except transient)	Compressor outlet pressure
Discharge gas temperature	95 °C or below	Compressor outlet temperature
Oil temperature	100 °C or below (Ambient temperature +10 K or above)	
Ambient temperature	-15 °C to +43 °C	Gas cooler intake air temperature
Power source	~50 Hz 220 V / 230 V / 240 V	Within ± 10 % of Rate Voltage
Installation inclination angle	1° or below	
ON/OFF cycle period	10 minutes or longer for ON/OFF cycle	Oil return shall be ensured
Installation	Outdoor	The foundation shall be rigid enough
Climatic class	0/1/2/3/4/6/8	Please see below "CLIMATIC CLASS"

* Operation may not be possible depending on the installed condition.

CLIMATIC CLASS

Test room climate class	Dry bulb temperature °C	Relative humidity %	Dew point °C	Water vapour mass in dry air g/kg
0	20	50	9.3	7.3
1	16	80	12.6	9.1
2	22	65	15.2	10.8
3	25	60	16.7	12.0
4	30	55	20.0	14.8
6	27	70	21.1	15.8
8	23.9	55	14.3	10.2

Excerpt from: EN ISO 23953

Countermeasures in a cold weather operation

In order to prevent excessive reduction of high pressure in a cold weather location, surrounding around the refrigeration unit should be made.

Scope of Application, Specifications

Rated Specifications

Item	Rating	Unit
Power source	~50 Hz 220/230/240	V
Power input	1.80/1.79/1.79	kW
Current	8.31/7.94/7.60	A

Conditions

1. Evaporating temperature: -10 °C ,
2. Ambient temperature: 32 °C
3. Compressor rotational speed : 65 s⁻¹
4. Suction superheat : 10K

Performances (220 V / 230 V / 240 V)

Ambient temperature	Item	Symbol	Evaporating temperature		Unit
		T	-10 °C	-35 °C	
32 °C	Cooling capacity	P _A	3.70/3.70/3.70	1.80/1.80/1.80	kW
	Power input	D _A	1.80/1.79/1.79	1.66/1.65/1.65	kW
	COP	COP _A	2.06/2.07/2.07	1.08/1.09/1.09	
25 °C	Cooling capacity	P ₂	3.85/3.85/3.85	1.91/1.91/1.91	kW
	Power input	D ₂	1.47/1.47/1.47	1.44/1.44/1.44	kW
	COP	COP ₂	2.62/2.62/2.62	1.33/1.33/1.33	
43 °C	Cooling capacity	P ₃	3.10/3.10/3.10	1.54/1.54/1.54	kW
	Power input	D ₃	2.04/2.03/2.03	2.01/2.01/2.01	kW
	COP	COP ₃	1.52/1.53/1.53	0.77/0.77/0.77	

Compressor rotational speed : 65 s⁻¹, Suction superheat : 10K

Sound pressure level

The A-weighted sound pressure level does not exceed 70 dB(A).
(at a distance of 1 m from surface of product)

CO₂ Refrigerant Grade

Charge CO₂ refrigerant (R744) that is compatible with following specifications.

Item	Specifications
Purity	> 99.9 % (volume)
Moisture	< 0.005 % (volume)
Total sulfur	< 0.03 ppm (weight)
Inert gas (H ₂ , N ₂ , O ₂ , Ar)	< 0.01 % (volume)

For Effectively Using the Refrigeration Unit

Cautions for Installation Work

This refrigeration unit has been designed exclusively for R744 (CO₂ refrigerant).

Refrigeration oil and each component including the compressor have been exclusively designed for the refrigeration unit.

Please use sufficient caution for maintaining the reliability of the product.

- (1) Since CO₂ refrigeration cycle becomes high pressure during operation, use the piping material and other components particularly designed for CO₂ refrigerant with sufficient strength.
- (2) As the refrigeration oil has high moisture absorption property, make the opening time as short as possible. Connection of the piping to the refrigeration unit should be made at the last stage of piping installation work. Avoid outdoor work on a rainy day.
- (3) For piping work, use “phosphorous-deoxidized copper pipe” of refrigeration grade, clean, dehydrated and “phosphor-copper brazing solder”.
If “silver brazing solder” is to be used, do not use any flux containing chlorine. During pipe brazing it is a must to use nitrogen over pressure.
- (4) Do not use pipe joints made for HFC refrigerant, because they do not have the required strength. In addition, absolutely do not use flared joints.
- (5) For the purpose of protecting the refrigeration unit and refrigeration cycle, be sure to install the included filter dryer at the liquid line of the refrigeration unit.
- (6) Gas leak detector used for airtight test should be foaming liquid or soap water. Do not use kitchen detergent. Kitchen detergent may corrode metals.

For Economically Using the Refrigeration Unit

For the purpose of using the refrigeration unit economically, consider the following.

Cooling capacity largely vary by the method of use.

Reduction of evaporating temperature (unit inlet pressure converted to temperature) reduces cooling capacity by 3 to 4%, and increase of discharge pressure decreases cooling capacity and increases power consumption.

In order to fully extract the unit performance, compressor suction pressure should be increased as high as possible, and discharge pressure should be made as low as possible. For this reason, caution should be used in the following points.

- (1) Make the piping resistance as small as possible.
Ref: Capacity change rate per 1 °C pressure loss of suction line

Evaporating temperature	Capacity change rate per 1 °C
-45 °C to -5 °C	3 % to 4 %

- (2) Select an evaporator of sufficient capacity for raising evaporating temperature as high as possible.
- (3) Do not block the cold air outlet in a refrigerator, freezer, or showcase with food items.
- (4) Operate door opening of a refrigerator or freezer as quick as possible. (To avoid leak of cold air, reduce the time of door opening)
- (5) Periodically perform cleaning of the gas cooler to avoid clogging.

For Effectively Using the Refrigeration Unit

Caution for an Inverter-based Refrigeration Unit

- (1) Even after turning the power OFF, voltage still remains in the charged part. Until the LED (red) of the INV-EN-PCB turns off (until the capacitor discharges the potential), approximately 5 minutes are required. Do not touch the charged part.
- (2) Phase-advancing capacitor is prohibited
Do not attach a phase-advancing capacitor to an inverter compressor. It may cause inverter failure or capacitor breakage.
- (3) Inverter noise prevention
Take as much distance as possible from the wiring of a radio receiver or wired broadcasting.
Inverter noise may cause undesired noise sound.
- (4) The two-stage compression mechanism prevents temperature rise of the second stage discharge gas of the compressor.
During the operation with a small quantity of refrigerant in the refrigeration circuit, a protection device (the CR1-EN-PCB) makes the compressor to stop. Avoid refrigerant shortage operation.
- (5) Rotary compressor consists of high precision components. Use caution during piping work to avoid contamination of dust, metal powder, or oxide scale, etc.

Initial Oil Quantity

Model No.	Compressor
OCU-CR200VF5(SL)	300 mL
Oil type	PZ-68S

Caution

When adding oil or changing oil, be sure to use our specified oil.

Selection of Installation Location

General Cautions

Each unit of the equipment should be placed by selecting the most convenient location such as easy to install, operate or maintain.

- (1) Each unit should be placed to make the piping and wiring length as short as possible and easy to install.
- (2) Controller should be located within the reach of the user's hand for convenient daily operations (RUN, STOP, reset warning, etc.). Do not locate the controller in a place easily accessed by the people other than the user.
- (3) Install the refrigeration unit at a location easy to be serviced for daily maintenance and inspection.
Daily maintenance and inspection involves checking the operation pressure, compressor operation condition for abnormal sound or vibration.

Selection of Installation Location

Location not disturbing neighbors

Avoid air-blow from the gas cooler to the neighbor's window or noise to disturb other people.

Location with a sturdy and level surface

Install the refrigeration unit on a firm foundation to avoid an increase of noise and vibration. Particularly at the boundary from the neighbor's lot, comply with the regional laws and regulations.

Location away from a heat source

Installation should not be affected by reflection from the floor.

Location with good ventilation

To ensure good ventilation, installed location should ensure the intake air by the gas cooler is 43 °C or below with good airflow.

Location not affected by a wet floor

Refrigeration unit is often affected by rainwater and drain water from defrosting. Apply drain water work as required.

Location not affected by snow accumulation

Installation in a cold weather location should avoid snow accumulation and attachment of frost or freezing by furnishing a roof.

Direction for avoiding strong wind

Install the refrigeration unit with its blow-out side facing perpendicular to the wind direction.

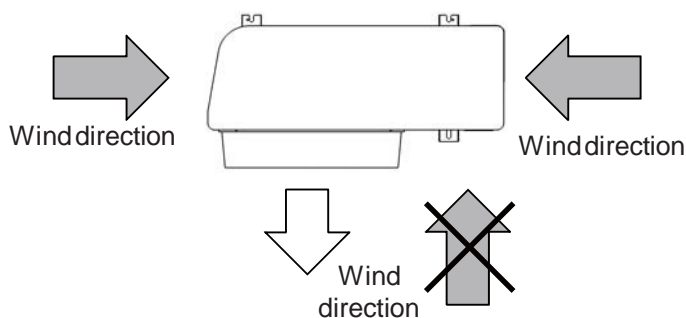

Carry-in/Installation

Carry-in Operation

- (1) Carry the refrigeration unit gently by keeping the vertical position as much as possible.
- (2) Absolutely avoid a lay-down position of the refrigeration unit.
- (3) When carrying the refrigeration unit by a forklift, use a packaging wood base or pallet for maintaining the refrigeration unit in the vertical position.

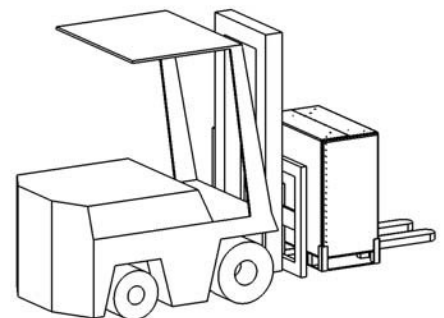

Carry-in/Installation

Foundation/Platform Work

- As a reference, the foundation should be made from concrete having a mass about 3 times that of the refrigeration unit. (Absorbing vibration by mass)
- Vibration should be reduced by a platform or anti-vibration pad for avoiding transmission of vibration to the floor and wall.
- To avoid falling, secure the refrigeration unit by using anchor bolts. (Use all securing positions)
- The refrigeration unit must be installed with an inclination angle 1° or below.

If a foundation meeting the requirement above cannot be secured, be sure to check that no abnormal vibration is generated by resonance of the refrigeration unit and piping system.

- (1) Standard foundation work
On a concrete foundation 150 mm or higher from the floor surface, place anti-vibration pads (Approx. 8 to 15 mm thick) and secure the unit on the entire unit base by anchor bolts.
- (2) When using angles
Secure angles on a firm concrete foundation by using anchor bolts.
- (3) Anchor bolts
Use M8 size anchor bolts and buried at least 100 mm on the concrete foundation.
Fix unit with double nut and plain washer (28 mm O.D. minimum).

External Dimensions

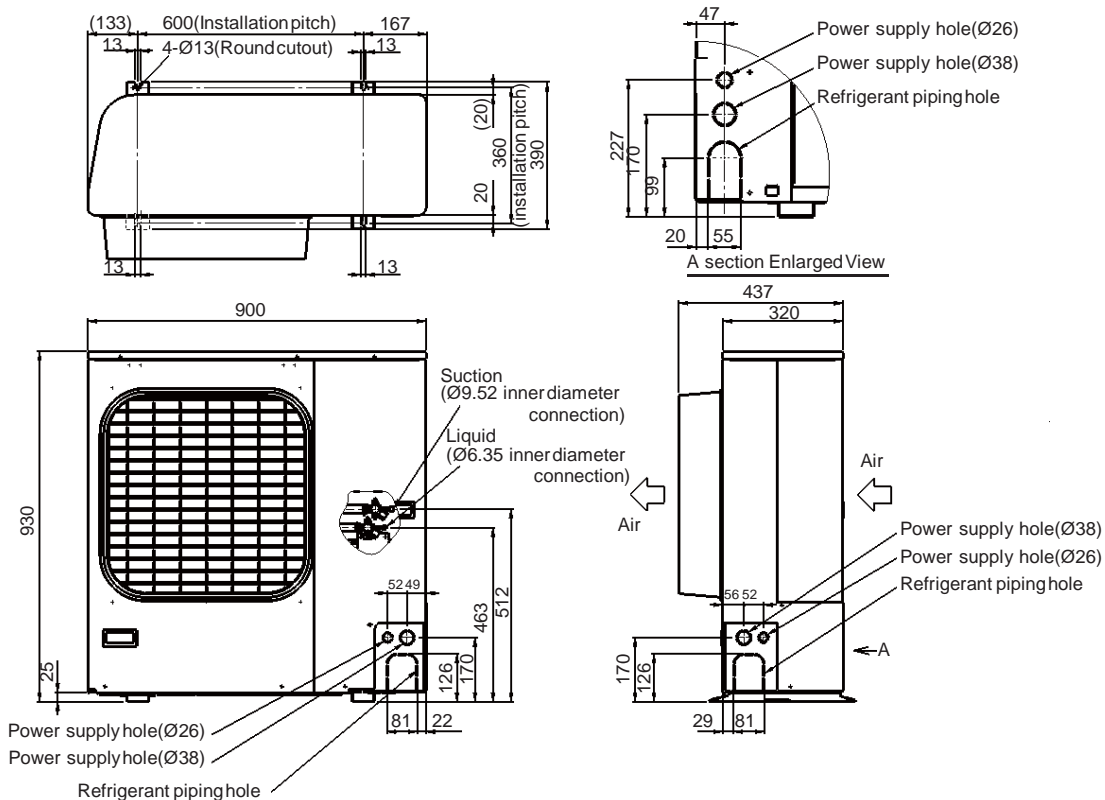

Optional Accessories

The following service piping (optional) is required for the installation and service work of the refrigeration unit.

Service piping for Evacuation, Airtight test, and Refrigerant charging (Model No. SPK-TU125)

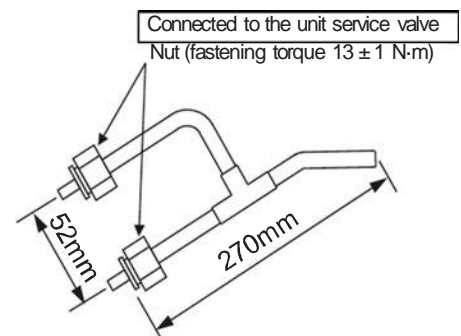

Installation Example

When no obstruction exists in the blow-out side

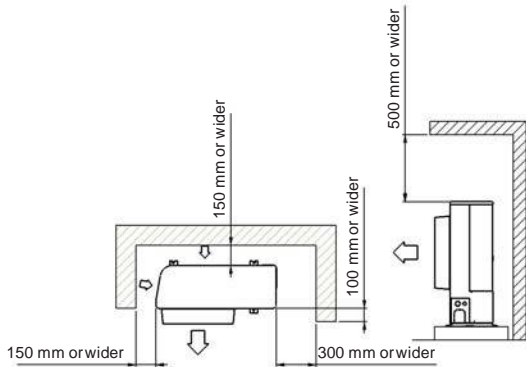

When an obstruction exists in the blow-out side

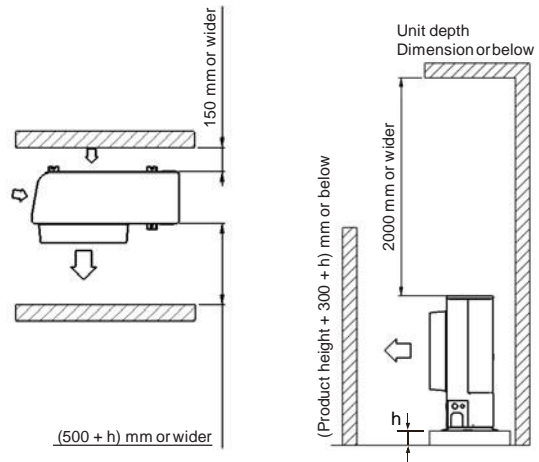

Stacked installation

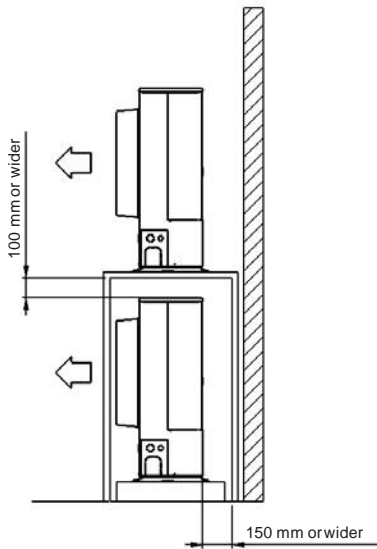

When installing next to a top-blow refrigeration unit

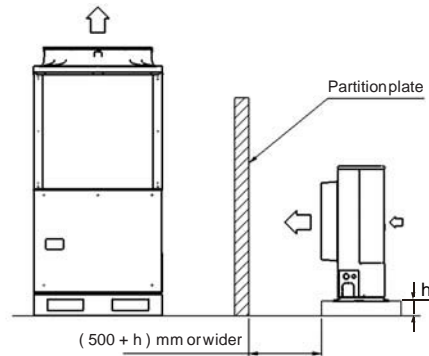

Avoid direct entry of the blow-out heat into the heat exchanger of the top-blow refrigeration unit. When installation cannot be avoided, install a partition plate.

In the case of face-to-face installation

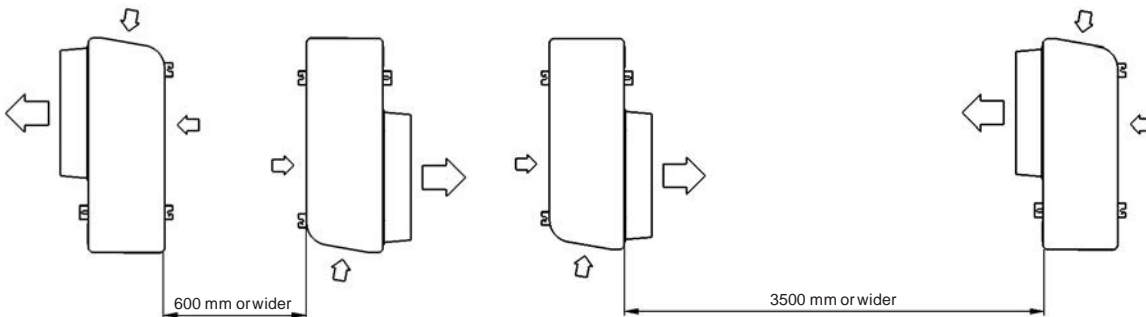

Installation Example

When installing next to a top-blow refrigeration unit

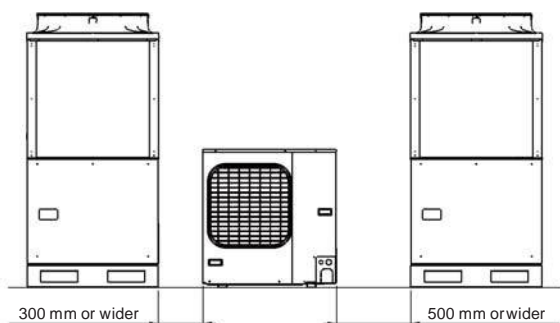

Avoid direct entry of the blow-out heat into the heat exchanger of the top-blow refrigeration unit.

Side-by-side installation

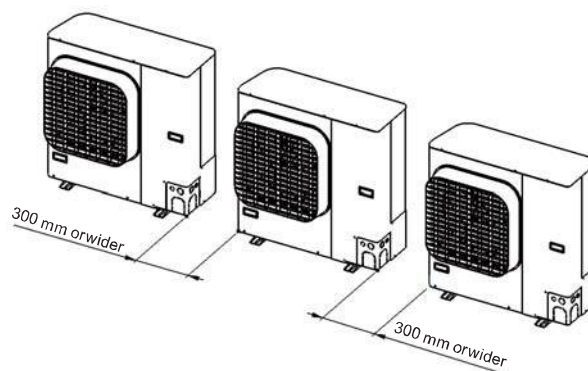

Refrigerant Piping Work

Design and installation of the refrigerant piping work largely affect the performance of the refrigeration unit as well as the product life and problem occurrence.

Installation work should comply with the following items. Installation of all equipment have to be in accordance to Pressure directive 97/23/EC and European norm EN 378.

Selection of Refrigerant Piping Size

The connection piping size for refrigeration unit is, in principle, as shown below, but each should be determined by calculating pressure loss of the piping and refrigerant flow speed and making sure no problem occurs in the cooling capacity and oil return.

As refrigeration unit using CO₂ refrigerant incurs pressure higher than when using HFC refrigerant, it is necessary to choose adequate materials.

Model No.	Suction line (Unit inlet)	Liquid line (Unit outlet)
OCU-CR200VF5(SL)	Ø9.52 mm, 3/8"	Ø6.35 mm, 1/4"

Note: Welding is inner diameter welding.

- Piping material should be seamless phosphorous-deoxidized copper pipes (refrigeration grade), K65.
- When cutting pipe, use a pipe cutter and always remove burrs.
- When bending pipe, secure a bending radius 4 times or greater of the outer diameter. During bending, pay attention to distortion and scars.
- When the connection length of the suction line is 15 m or shorter, increase piping size by 1 rank for improving startability of the refrigeration unit. To secure starting performance.
(Piping size of the suction line: Ø 9.52 mm → Ø 12.7 mm)

Caution

Use sufficient caution for handling piping by sealing the pipe end with tape or any other cover for avoiding entry of contaminants and moisture into the pipe.

Refrigerant Piping Work

Cautions for Heat Insulation Work

- Apply heat insulation on the suction line and liquid line for avoiding thermal effect from outside.
- Do not wrap together the suction line and liquid line with heat insulation material. (Refer to the right illustration)
- Apply heat insulation only after executing airtight and pressure test.

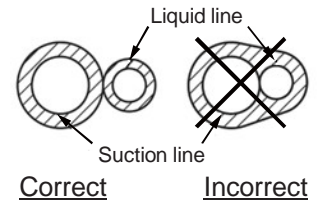

Prevent contamination of foreign objects such as dust, metal powder, oxide scale, etc.

Since the compressor consists of high precision components, contaminants generate scratches on the sliding surfaces, thereby increasing gas leak, deteriorating performance, and causing excessive wear and seizure.

- Flow nitrogen gas during welding.
- Piping inside and outside must be clean.
- Avoid mixing of debris during cutting and deburring copper pipe.

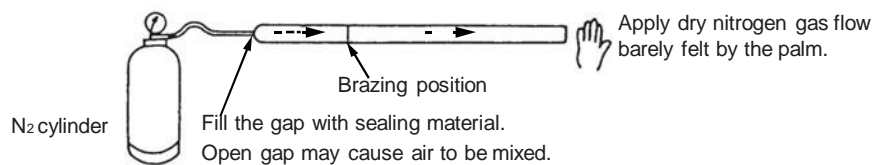

Airtight Test

[Execute this test after completing piping work but before starting heat insulation work]

Testing pressure should comply with the following.

High pressure side	Low pressure side
12MPa	8MPa

Piping Direction

The pipe can be connected from 3 directions (front, back, or right side of the unit).

When connecting the refrigerant pipe, remove the right side panel.

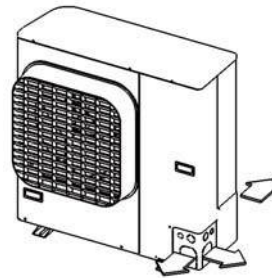

Caution for Gas Leak

Gas leak may lead to excessive heat operation of compressor and air-mixed operation, thus causing compressor failure. Securely execute airtight test.

Filter Dryer

Be sure to attach the included filter dryer. Model No. D-152T (Type: CO-082-S)

Piping Example

Total piping length should be limited to 25 m one way.

When the evaporator is located higher

- Height difference 5 m or below
- The suction line should ideally slope gently towards the unit. Recommendation slope is 1/200~1/250.
- Refrigerant pipe should be covered with heat insulation material on both suction line and liquid line. Since liquid line becomes approx. 0 °C during operation, apply heat insulation of 20 mm or more in thickness.

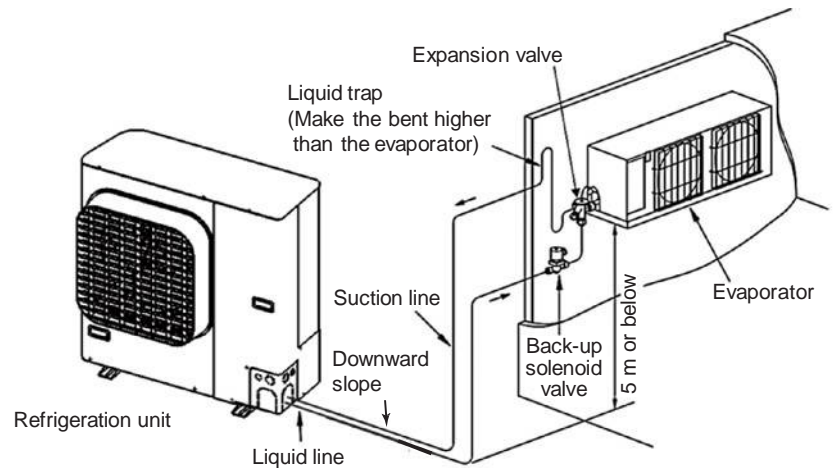

When the evaporator is located lower

- Height difference 10 m or below
- To promote good oil return in the suction line, piping size and trap need to be considered.
- The suction line should ideally slope gently towards the unit. Recommendation slope is 1/200~1/250.
- Refrigerant pipe should be covered with heat insulation material on both suction line and liquid line. Since liquid line becomes approx. 0 °C during operation, apply heat insulation of 20 mm or more in thickness.

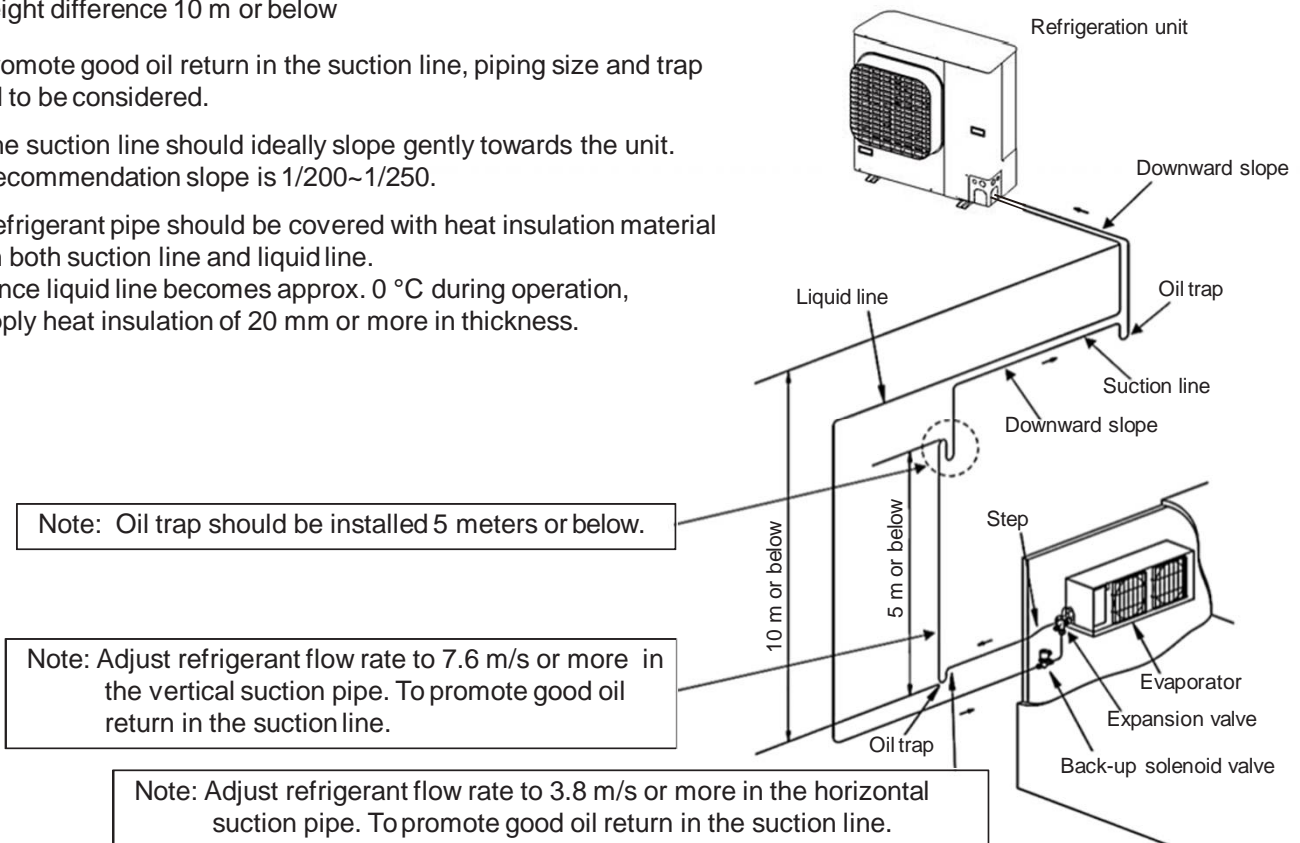

Refrigerant Circuit Diagram

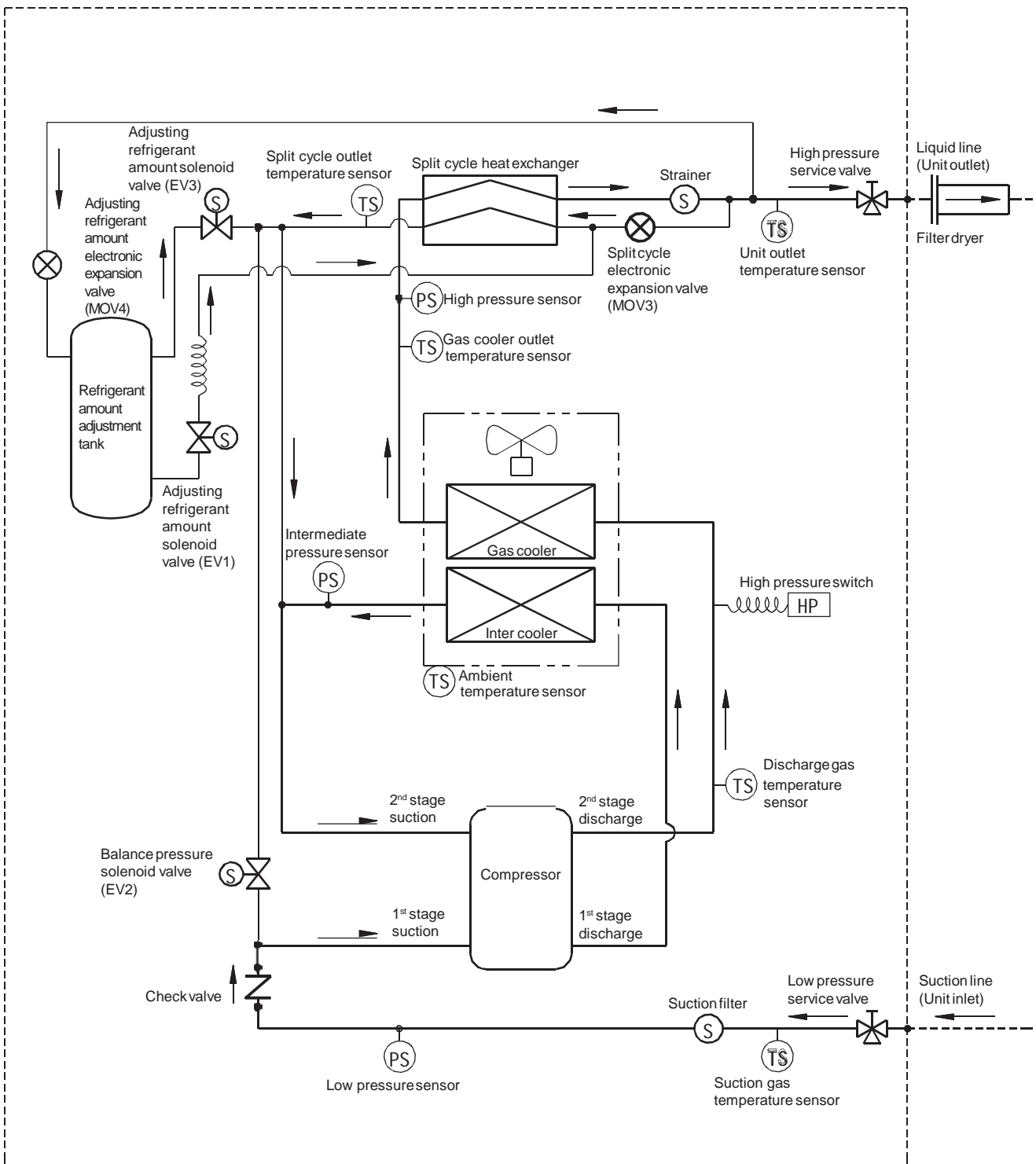

Refrigerant Charging

Evacuation (Perform after completing electrical wiring.)

To avoid inclusion of air or moisture in the refrigerant circuit, be sure to execute vacuum drying of the entire circuit before charging refrigerant by using a vacuum pump. Execute evacuation after securely carrying out airtight test by using the following sequence.

Before starting evacuation, refer to the Engineering Service Manual "Vacuum Pump Attachment and Evacuation Procedure".

- (1) Connect electrical wiring
Before starting evacuation, electronic expansion valve and solenoid valve need be opened.
- (2) Before Power ON
 - Turn ON the operation switch S1.
 - Turn ON the 8P DIP switch (SW13) No.1.
 - Set the Slide switch (SW15 [CONTROL/CHECK]) to [CHECK].
- (3) Power ON
Check that [uAcU] is displayed on the 7-segment LED.
Set the rotary switch(SW11) to [OPERATION].
then "Low Pressure → High Pressure → [uAcU] → Low Pressure → ...",
will be displayed in order on the 7-segment LED. ...
Electronic expansion and solenoid valves open.
- (4) Evacuation
 - Connect a pressure gauge (vacuum pressure gauge) and vacuum pump to the low pressure and high pressure service ports, and apply evacuation from the two ports.
 - Evacuate down to 133 Pa (1 Torr), the target level for evacuation, and continue for 1 to 3 hours.
- (5) After evacuation
 - Charge the refrigerant up to approximately 0.5MPa.
 - Set the Slide switch (SW15 [CONTROL/CHECK]) to [CONTROL].
 - Turn OFF the 8P DIP switch(SW13) No.1.
 - Turn OFF the operation switch S1.

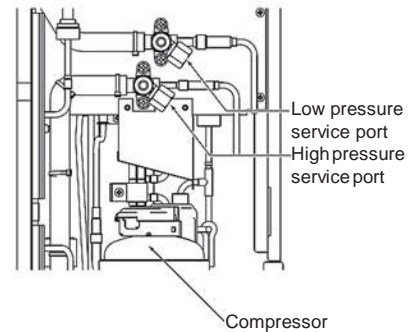

Refrigerant Charging

- (1) Execute refrigerant charging immediately after evacuation.
- (2) Charge refrigerant R744 (CO₂ refrigerant).
- (3) Do not mix with other refrigerant.

Refrigerant Charging

Method of Charging

- (1) Close the vacuum valve of the manifold gauge set exclusively for CO₂ refrigerant, and separate the vacuum pump.
- (2) Place the refrigerant cylinder on the platform scale, and open the refrigerant cylinder valve and manifold gauge set charging valve.
Note: 1. Close the low pressure and high pressure service ports.
2. Place the platform scale on a flat surface and perform zero-point adjustment.
- (3) With the refrigeration unit being stopped, open the joint valve attached to the service piping and high pressure service port, and charge liquid state refrigerant from the high pressure service port.
Calculate the initial refrigerant charging quantity by using the formula below. (Max:2.2kg)
In the case of a freezer reach-in case = 1,260 (g) + 12 (g / m) x piping length (one-way: m)
In the case of a refrigeration showcase = 825 (g / m) x showcase length (m) + 12 (g / m) x piping length (one-way: m)
Note: 1. Do not absolutely charge liquid refrigerant from the low pressure side (low pressure service port).
2. To avoid overcharging, charging rate should be around 20 g per 5 sec.
3. If it is difficult to adjust refrigerant charging rate by operating the joint valve and manifold gauge set charging valve, attach a capillary tube between the refrigerant cylinder and manifold gauge set.
4. Do not attach a capillary tube between the manifold gauge set and service piping.
5. For the method of charging refrigerant, refer to the service manual "Refrigerant Charging Operation Procedure".
- (4) When the liquid refrigerant no longer goes into the refrigeration unit, close the high pressure service port and make the refrigeration unit in cooling operation condition to adjust refrigerant quantity.
Note: Refrigerant quantity adjustment should conform to the "Refrigerant Quantity Adjustment of Refrigeration Unit" in the section "Adjustment during Operation".
- (5) After completing refrigerant quantity adjustment, close the refrigerant cylinder valve and check that the low pressure and high pressure service ports have been closed.
- (6) Slowly open the vacuum valve or purge port of the manifold gauge set to emit the remaining refrigerant in the service piping and manifold gauge set.
Note: Since refrigerant becomes cold when released, use caution when opening the valve for frost bite.
- (7) After completing the operation, check gland nut loosening of the low pressure and high pressure service valves and fasten them if any looseness exists. Fastening torque is 10 ± 2 N·m.

Cautions for Electrical Wiring Work

Electrical work must be carried out by a certified electrician according to the local requirements, regulations and laws.

Electrical Shock and Fire Prevention

- (1) Apply grounding wiring.
- (2) The circuit must not be shared with other circuits. (The wire should not be shared with other equipment)
- (3) Electric wire should not touch high temperature components (compressor, gas cooler, discharge piping, etc.) and any metal edge.

Selection of a Ground Fault Protector and Wiring

Model No.	Ground fault protector		Power line thickness for wiring length (mm ²)				Grounding wire thickness (mm ²)	Control circuit thickness (mm ²)
	Rated current	Detected current	10 m	20 m	30 m	50 m		
OCU-CR200VF5(SL)	16 A	30 mA	2.5	2.5	2.5	2.5	2.5	1.0

Notes:

1. Wiring and cabling quality need to follow local standards, regulations and laws. IEC: 60245 IEC57
CENELEC: H05RN-F
2. Use shielded cable for communication line, liquid tube electromagnetic valve line and showcase operation signal line.

Electrical Wiring Work

Wiring Block Diagram Example

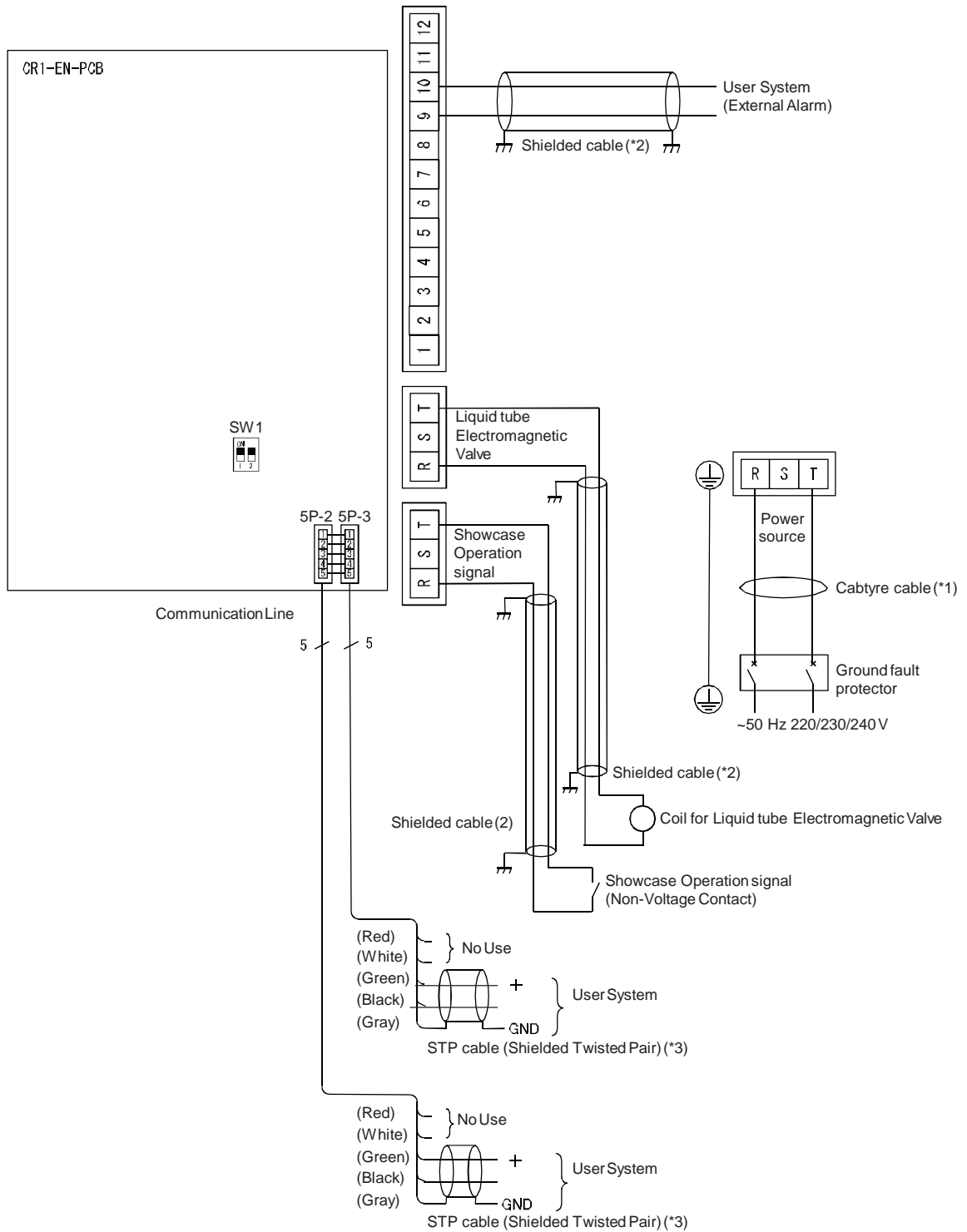

Caution

*1 : Use the cabtyre cable Power Line.

*2 : Use shielded cable for liquid tube electromagnetic valve line, showcase operation signal line and external Alarm Line.

The shield Line connect the screw with FIL-EN-PCB earth line when the shield Line do not ground at the connected equipment.

*3 : Use shielded twisted pair cable for communicationline.

Electrical Wiring Work

Wiring Guide Opening

Wiring guide opening is located at the front, back and right side surfaces. (Power supply holes of $\varnothing 26$ and $\varnothing 38$ are furnished in three directions)

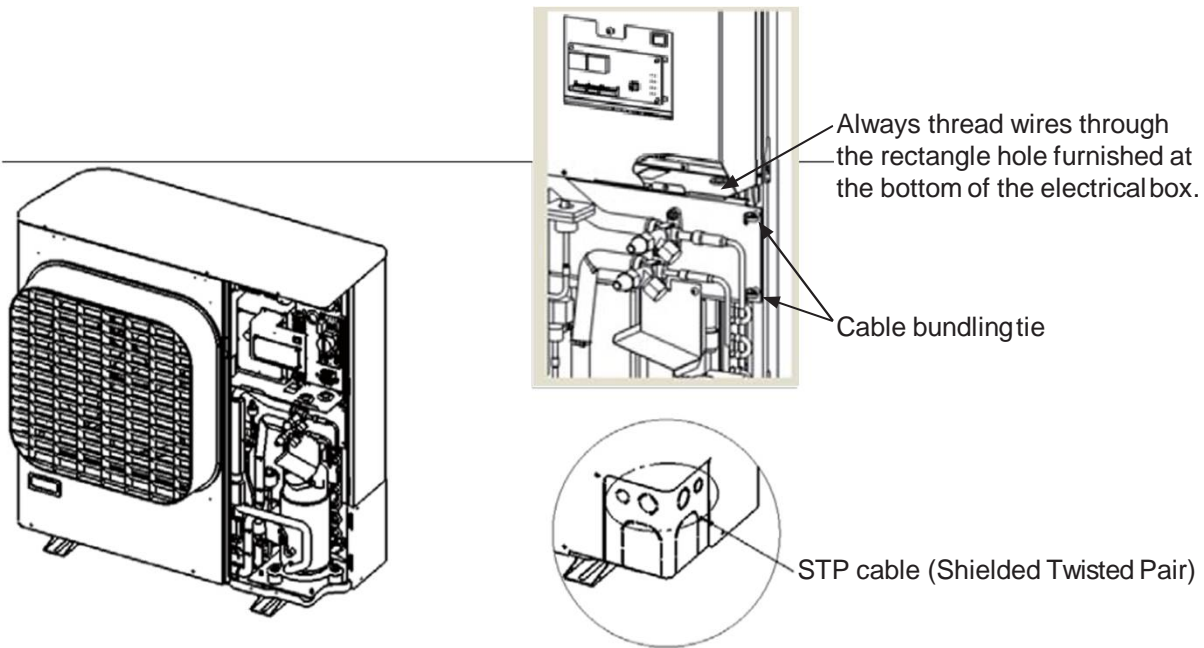

Use a cable bundling tie to eliminate wire slack without touching the sheet metal.

Power line and communication line connect to Refrigeration Unit through conduit.

Caution

When the panel attachment after work is incomplete, penetration of rainwater is possible. Securely fasten the panels after work.

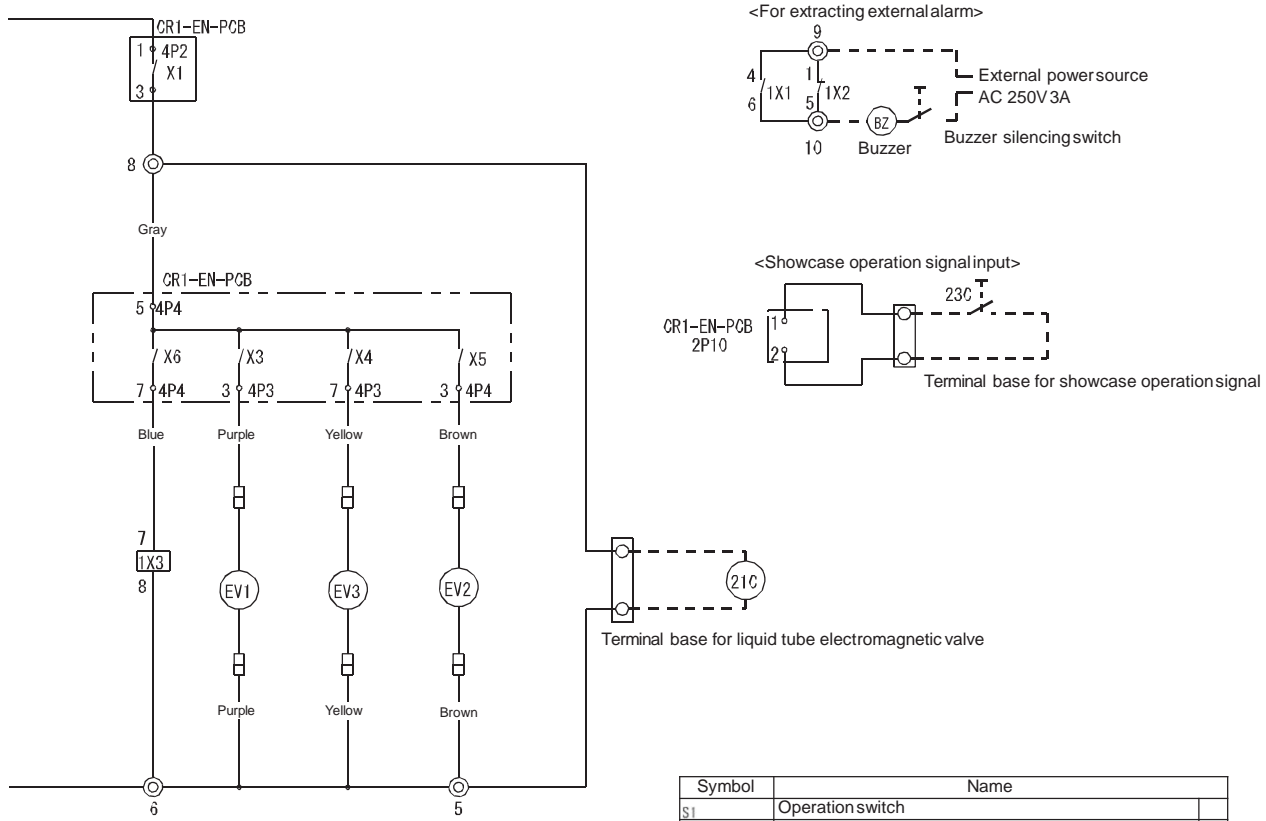

Electrical box internal layout

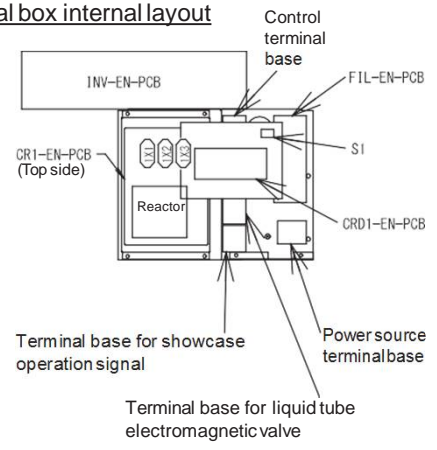

Symbol	Name	
S1	Operation switch	
1X1-3	Auxiliary relay	
CM	Compressor motor	
CH	Crankcase heater	
CF	Gas cooler fan motor	
MOV3	Split cycle electronic expansion valve	
MOV4	Adjusting refrigerant amount electronic expansion valve	
CR1-EN-PCB	Compressor control X1: Operation/protection, X2: External alarm X3 to X5: Electromagnetic valve, X6: Operation signal	
EV1	Adjusting refrigerant amount solenoid Valve	
EV2	Balance pressure solenoid valve	
EV3	Adjusting refrigerant amount solenoid Valve	
EB1	Ground fault protector	*
21C	Liquid tube electromagnetic valve	
23C	Compartment temperature adjustment thermostat	*2
63H	High pressure switch	
Ⓞ	Control terminal base	
	Factory wiring	
	Local wiring	

(Cautions)

1. Connect the grounding wire at the indication label without fail.
2. The components marked * need to be acquired locally. However, *2 is included in the showcase.
3. Connect external alarm(no-voltage contact) at the terminal 9-10.
4. Stopping the refrigerating equipment: Turn S1 to stop. To stop for a long time, turn OFF also EB1.
5. When alarm is generated, check the abnormality content, eliminate the cause of the problem, and then turn ON the power
6. Local wiring should be shielded cable.

What Needs to be Checked before Operation

Confirmation before Operation

- (1) Please recheck if any incorrect wiring or loose wiring exists.
- (2) Fully open all service valves.
- (3) Check that the power supply voltage is within $\pm 10\%$ of the rated voltage
- (4) Check that insulation resistance is 1 M Ω or greater.

Power Supply to the Crankcase Heater

When restarting after power shutoff of the ground fault protector, crankcase heater must be turned ON for 6 hours or longer before operating the compressor for avoiding oil-forming at starting.

(With the operation switch on the refrigeration unit side OFF, and the ground fault protector ON, wait for 6 hours or longer before turning ON the operation switch.)

Caution

Turning the ground fault protector ON causes power to be applied to the crankcase heater. Do not touch by hand.

Protection of High Pressure

The set value of high pressure abnormality is shown in the table below.

Refrigerant	R744
Set value	11.7MPa

Setting and Indication

This refrigeration unit is equipped with the function of setting a variety of compressor operation modes by the switch on the CRD1-EN-PCB.

Operating condition of the compressor can be checked by the 7-segment LED.

In particular, when any abnormality occurs in the refrigeration unit, an alarm LED (Red) lights up or blinks, and the cause of abnormality is displayed digitally by an error code.

Switch and Indication

CRD1-EN-PCB

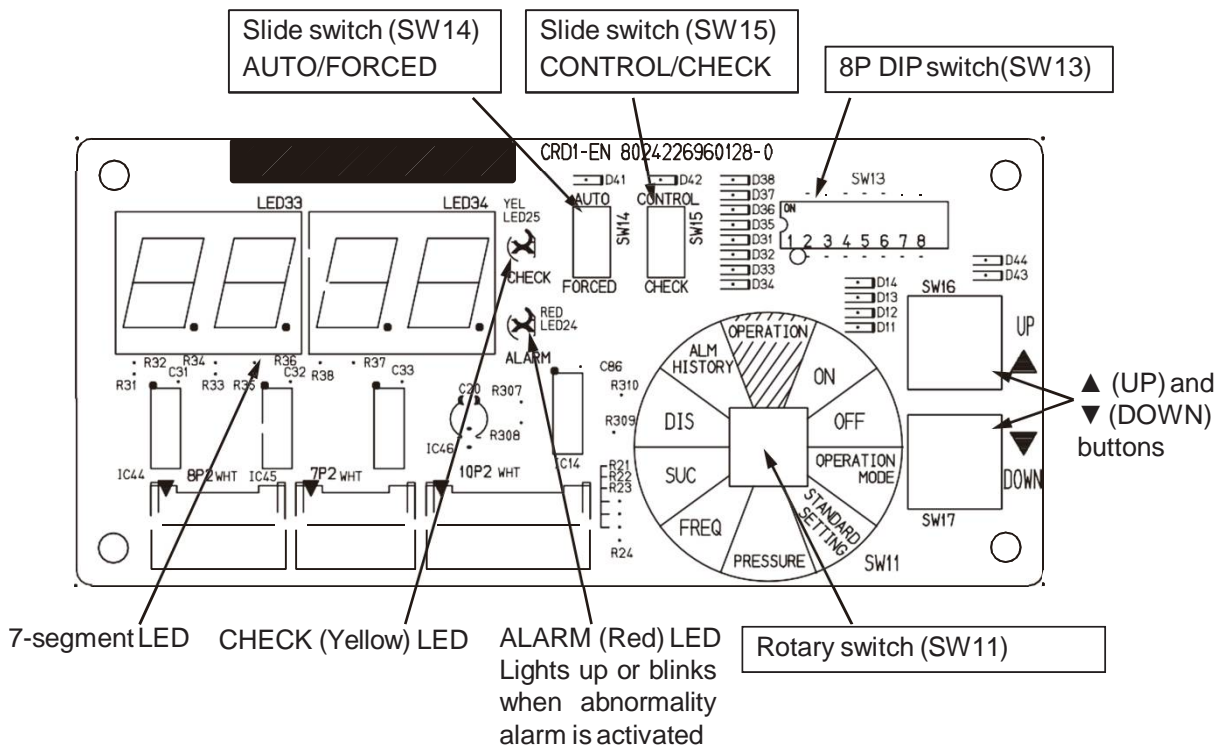

Setting and Indication

Switch Setting

(1) AUTO/FORCED switch (Slide switch, SW14)

SW14	Function	Remarks
	Auto operation	
	Forced operation	Not yet used

(2) CONTROL/CHECK switch (Slide switch, SW15)

SW15	Function	Remarks
	Normal Mode	
	Special Mode	Evacuation Mode (DIP switch SW13 setting is also required)

(3) 8P DIP switch (SW13)

The following functions can be selected. Change setting as required.

Switch setting at factory shipment is No.2: ON, other (No.1, No.3~No.8) : OFF.

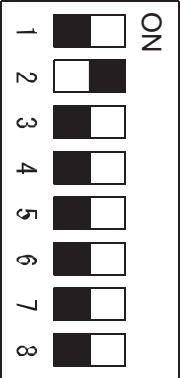
SW13	No.	Function with ON	Remarks
	1	Evacuation	No.6: OFF, SW15: CHECK
	2	Do not operate	
	3		
	4		
	5		
	6		
	7	Back mode 2	No.3, No.5, No.8: OFF
	8	Back mode 1	No.3, No.5, No.7: OFF

Setting and Indication

Low Pressure Setting

- (1) Turn OFF the operation switch S1.
- (2) Power ON
- (3) Low Pressure Setting (ON value, OFF value, Diff.value)
 The Low pressure setting at the shipment is as shown in No.4 of the "Standard Pressure Setup Table" below.
 Since the Target Low Pressure Setting can be changed, use the following procedure as required.
 - Turn OFF the 8P DIP switch (SW13) No.1 and No.3 ~ No.8 (All OFF except No.2)
 - Set the rotary switch(SW11) to "Standard Pressure Setting".
 The 7-segment LED displays [F].
 - Press ▲ or ▼ button to select the desired number . . . Each set value for the number is shown in the table below.
 - Set the rotary switch (SW11) to [OPERATION]

<Standard Pressure Setup Table>

No.	Use	Compartment temperature (°C)	Evaporating temperature (°C)	ON value (MPa)	OFF value (MPa)	Low-press. Diff. value (MPa)	Lim value (MPa)
1	Refrigerator	+2 to +5	-8	2.96	2.80	0.90	1.90
2	Veg, fruits, etc.	0 to +4	-10	2.80	2.64	0.90	1.74
3	Meat, fish	0 to +4	-15	2.34	2.26	0.90	1.36
4	Freezer, ice	-18 to -20	-30	1.52	1.42	0.24	1.18

Lim value: Lowest low pressure to cause the compressor to stop. Lim value = OFF value - Diff. value

- (4) Target Low Pressure confirm and adjustment
 - Turn ON the 8P DIP switch (SW13) No.8.
 - Turn OFF the 8P DIP switch (SW13) No.1 and No.3 ~ No.7.
 - Set the rotary switch(SW11) to [ON]
 The 7-segment LED displays "ON value".
 To change the ON value, press ▲ or ▼ button.
 "ON value" range is from 0.76 MPa to 5.00 MPa, and it must be larger than "OFF value" by 0.08 MPa or more.
 - Set the rotary switch(SW11) to [OFF]. The 7-segment LED displays "OFF value".
 To change the OFF value, press ▲ or ▼ button.
 "OFF value" range is from 0.68 MPa to 4.92 MPa, and it must be smaller than "ON value" by 0.08 MPa or more.
 - Set the rotary switch(SW11) to [OPERATION MODE].
 The 7-segment LED displays "Diff. value".
 To change the Diff.value, press ▲ or ▼ button.
 "Diff. value" range is from 0.08 MPa to 1.84 MPa, and "Lim value" must be 0.58 MPa or more.
 - Set the rotary switch(SW11) to [OPERATION].
 Then the ON value and OFF value are stored in memory.

Setting and Indication

Indication

(1) IndividualLED

1. +5 V, +12 V (Yellow) Lights up when power is supplied to CR1-EN-PCB.
2. Alarm (Red) Lights up or blinks when abnormality or alarm occurred.
For detail, refer to the "Explanation of Abnormality Alarm" in "About Alarms".
3. Check (Yellow) Lights up: "check mode" or "evacuation mode"
Blinks: Slide switch SW15 ([CONTROL/CHECK]) is set to [CHECK].

(2) 7-segmentLED

When the rotary switch (SW11) is at [OPERATION], the display indicates 1. through 4. below.

1. Normal operation

Low pressure (MPa) and high pressure (MPa) is indicated alternately in every 3 seconds.
Indicates [Lo] when the low pressure is below 0.00MPa.
Indicates [H] at the end to identify the high pressure.

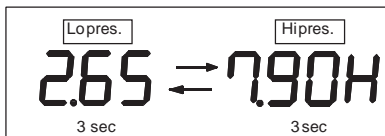

2. Alarm occurred.

Low pressure (MPa) → high pressure (MPa) → Error content is displayed repeatedly.

(E.g.)

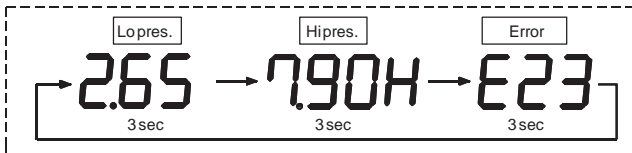

3. Method of fixing indication of low pressure

Pressing ▼ button during normal operation fixes the low pressure display for 10 minutes.
Pressing ▼ button again cancels the fixed display.
However, during alarm is generated, low pressure indication cannot be fixed.

4. The point at the lowest digit of the digital display (right bottom)



Blinks: Short cycle prevention function is in operation (compressor stopped).

Setting and Indication

Setting/Display Listing

Digital display and operation list

Mode	DIP switch SW13-8	DIP switch SW13-7	Rotary switch (Knob) position	Display/Setup	Remarks	
Standard mode	OFF	OFF	OPERATION	Low pressure and high pressure is displayed alternately.	Low pressure: Lo.0.00 to 9.98 (MPa) High pressure: Lo-H, 0.00H to *** H (MPa)	▲ pressing: Red LED blinking cancelled During pressing ▼ : evaporating temperature Pressing ▼ and release: low pressure (Only when no error is indicated)
			ON	"ON value"	0.76 to 5.00 (MPa)	Setting cannot be changed.
			OFF	"OFF value"	0.68 to 4.92 (MPa)	▲ pressing: "Lim value" ▼ pressing: "Diff value"
			OPERATION MODE	Operation mode	[FrE] display	Setting cannot be changed.
			STANDARD SETTING	Standard pressure selection	[F] display	▲ pressing: Up the set value ▼ pressing: Down the set value
			PRESSURE	Hi / Med / Lo pressure	High pres: *** H (MPa) Med pres: *** c (MPa) Low pres: *** (MPa)	▲ pressing: displayed data change ▼ pressing: displayed data change
			FREQUENCY	Compressor Rotational Speed	** . ** (s ⁻¹)	[Ex] In the case of 10 (s ⁻¹) → xx.0 In the case of less than 10 (s ⁻¹) → x.00
			SUCTION	Suction gas temperature	**** (°C)	▲ pressing: Suction heating rate(K) ▼ pressing: Unit outlet temperature (°C)
			DISCHARGE	Discharge gas temperature	**** (°C)	
			ALM HISTORY	Alarm history error code display	E *** (Error code) Latest 50 items (Older data erased)	▲ pressing: Older data ▼ pressing: Newer data
Back mode 1	ON	OFF	ON	"ON value" setting	0.76 to 5.00 (MPa)	▲ pressing: Up the set value ▼ pressing: Down the set value
			OFF	"OFF value" setting	0.68 to 4.92 (MPa)	
			OPERATION MODE	"Diff. value" setting	0.08 to 1.84 (MPa)	
			STANDARD SETTING	Forced stopping timesetting	30 sec to 180 sec (1 sec increment)	
			PRESSURE	Protocol type selection	1.PAn 2.oth 3.Mod	
			FREQUENCY	Address setting	0: No communication (Setting at shipment) 1 to 49: Pan/oth 1 to 50: Mod	▲ pressing: Up the set value ▼ pressing: Down the set value
			SUCTION	Operation mode	"FrE" display	Setting cannot be changed.
			DISCHARGE	—	—	—
			ALM HISTORY	—	—	—
Back mode 2	OFF	ON	ON	Hi / Med / Lo pressure display	High pres : *** H (MPa) Med pres : *** c (MPa) Low pres : *** (MPa)	▲ pressing: displayed data change ▼ pressing: displayed data change
			OFF	Other temperature display	Suction : ****(°C) Unit outlet : ****(°C) Split cycle outlet : ****(°C) Gas cooler outlet : ****(°C)	
			OPERATION MODE	—	—	—
			STANDARD SETTING	Electronic expansion valve opening	MOV3: 1. *** (step) MOV4: 2. *** (step)	▲ pressing: displayed data change ▼ pressing: displayed data change
			PRESSURE	—	—	—
			FREQUENCY	Compressor current	**** (A)	—
			SUCTION	Gas cooler fan speed	**** (rpm)	—
			DISCHARGE	—	—	▲ pressing: Software Version ▼ pressing: Erase Alarmhistory
ALM HISTORY	Ambient temperature	**** (°C)	—			

Control Functions

Low Pressure Control Method

Compressor capacity is controlled by changing the inverter frequency based on the difference between the low pressure and set value by adjusting the low pressure to the set value (ON value to OFF value).

However, compressor operation continues even if the low pressure becomes below "OFF value" and finally stops when the low pressure reaches below the "Lim value".

$$* \text{Lim value} = \text{OFF value} - \text{Diffvalue}$$

For the setting of Diff value, refer to "Low Pressure Setting" of "Setting and Indication".

Short Cycle Prevention Control

After the compressor has been stopped, and even the pressure becomes higher than the "ON value", stopping continues for the forced stopping time (30 to 180sec).

Control Functions

Protective Functions

- (1) High pressure abnormal, over current Stops the compressor.
- (2) Discharge gas temperature abnormal
 1. Normal operation
Compressor operation stops when the discharge gas temperature exceeds 118 °C, and resumes when the discharge gas temperature becomes 75 °C.
 2. When abnormal discharge gas temperature occurs 3 times in 2 hours.
Compressor is made to stop even the discharge gas temperature becomes 75 °C.

For the method of resuming (resetting) compressor operation, refer to the “Explanation of Abnormality Alarm” in “About Alarms”
- (3) Refrigerant flood back alarm
When the difference (suction gas superheat) between the suction gas temperature sensor value and evaporating temperature converted from the low pressure becomes 1 K or below for continuously 2 minutes, an error signal is indicated. During such condition, compressor operation continues.
Error indication is canceled when the suction gas superheat exceeds 5 K.
- (4) Sensor abnormality
 1. Open condition of low pressure, intermediate pressure sensor, high pressure sensor
Compressor stops with an error indication.
For the method of resuming (resetting) compressor operation, refer to the “Explanation of Abnormality Alarm” in “About Alarms”
 2. Open condition of discharge gas temperature sensor, gas cooler outlet temperature sensor, split cycle outlet temperature sensor, unit outlet temperature sensor, and ambient temperature sensor
Compressor stops with an error indication.
For the method of resuming (resetting) compressor operation, refer to the “Explanation of Abnormality Alarm” in “About Alarms”
 3. Open condition of suction gas temperature sensor
Error is indicated but the compressor continues operation.
Error is canceled when the sensor returns to normal, but the alarm (Red) LED maintains blinking condition.
- (5) Communication abnormality
While communication continues with the controller (external communication refrigerator No. is other than 0), if the controller data is not received for 10 minutes, then error is indicated. During such condition, compressor operation continues.
Error is canceled when data reception from the controller is resumed.

Caution

When the external communication refrigerator No. is set to other than 0 without connecting the controller, an error is displayed. Use caution.

Control Functions

(6) Inverter abnormality

Compressor stops when the following occurs, and resumes operation in 1 min. later.
Compressor stops when abnormality occurs 10 times per hour.

1. IPM protection
2. Voltage abnormality
3. Compressor over current
4. Compressor step out
5. PFC over current

(7) Inverter communication abnormality

When the inverter-PCB cannot receive data from the CR1-EN-PCB, compressor operation stops with error display.

For the method of resuming (resetting) compressor operation, refer to the “Explanation of Abnormality Alarm” in “About Alarms”

Adjustment during Operation

Avoiding Short Cycle Operations

Short cycle operation (frequent start/stop operation) causes excessive oil carry-over during starting and causes insufficient lubrication.

Adjust operation cycle to avoid short cycle operation. (Adjust ON-OFF cycle to be 10 minutes or longer.)

The main cause of short cycle operation is inappropriate pressure setting on CR1-EN-PCB, suction filter clogging, and unbalance of cooling capacity and load.

When a cooling coil is used, incorrect attachment position of the compartment temperature sensor (cold air-blow directly hit the sensor) would become a problem in addition to the above. Review the sensor position.

Checking the Operation Condition of the Refrigeration Unit

- (1) Check abnormal vibration of the refrigeration unit and piping.
- (2) Check insufficient or excessive charging of refrigerant. (Check gas cooler outlet temperature and high pressure)
- (3) Check if the set value of the expansion valve (electronic expansion valve) and thermostat is appropriate.
- (4) Check whether or not liquid return operation is permitted. (Check superheat of suction gas temperature)

Adjustment during Operation

Adjusting Refrigerant Quantity of the Refrigeration Unit

During determination of refrigerant quantity, temperature setting of all cooling coils of the showcase needs to be set to the lowest temperature without activation of the thermostat for making the refrigeration unit operating continuously.

(1) Method of determining refrigerant quantity

Check the operating condition of the refrigeration unit and adjust to the correct refrigerant quantity.

1. Set the low pressure according to the Table 1 and Table 2. (Refer to the "Low Pressure Setting" shown in the "Setting and Indication of the Control PCB".
2. Check that the suction gas temperature is 18 °C or below.
3. Check that the superheat of the suction gas temperature is secured by 10 K or higher.
4. When the showcase and cooling coils are fully cooled, check the superheat of the evaporator outlet temperature.
Set value of superheat ± 2 K is appropriate (6 to 10 K in the case of 8 K setup value)

Table 1 Refrigeration (Refrigerator, vegetable/daily foods, meat/fish)

ON value(MPa)	2.96
OFF value(MPa)	2.80

Table 2 Freezing (Freezer, ice)

ON value(MPa)	1.52
OFF value(MPa)	1.42

Caution

This setting is for determining refrigerant quantity. After finishing refrigerant quantity determination, change the setting of ON value and OFF value according to the purpose of operation. (Refer to the "Low Pressure Setting" shown in the "Setting and Indication of the Control PCB".

When charging refrigerant while ambient temperature is 25 °C or below, check superheat during summer season. The guideline of high pressure and intermediate pressure against ambient temperature is as shown in Table 3 and 4. Ambient temperature can be checked in the back mode 2. (Refer to the "List of Setting and Display" in the "Setting and Indication of the Control PCB")

Table 3 Refrigeration (Refrigerator, vegetable/daily foods, meat/fish)

Ambient temperature(°C)	25	30	35	40
High pressure (MPa)	7.5	7.9	8.4	8.8
Intermediate pressure (MPa)	4.7	5.0	5.3	5.6

Table 4 Freezing (Freezer, ice)

Ambient temperature(°C)	25	30	35	40
High pressure (MPa)	6.9	7.5	8.0	8.5
Intermediate pressure (MPa)	3.5	3.8	4.1	4.5

Caution

Shortage of refrigerant tends to cause lower level of high pressure and higher level of intermediate pressure.

Adjustment during Operation

(2) Refrigerant quantity adjustment

1. Shortage of refrigerant (when charging additional refrigerant)
 - Perform cooling operation and charge additional refrigerant from the low pressure service port.
 - Adjust valve opening during slow charging operation to avoid frosting beyond the refrigerant service valve.
 - Guideline of charging rate of refrigerant is 20 g per 5 sec. Rapid charging forces liquid slugging by the compressor and may lead to a failure.
2. Overcharging of refrigerant (when releasing the refrigerant)
 - Release the refrigerant from the low pressure service port.
 - Open the valve very slowly. Use caution for oil leak out. (Release refrigerant slowly to avoid oil leak out)
 - As CO2 refrigerant is heavier to air, use caution for gas stagnation.
3. After completing refrigerant adjustment, close the low pressure service port.

Caution

When charging refrigerant, refer to the Engineering Service Manual "Refrigerant Charging Procedure".

About Alarms

Installation of an Alarm System

This refrigeration unit has a variety of protection devices for securing safety. When the ground fault protector or other protection device is activated, and the alarm system or temperature control system is insufficient, cooling operation is stopped for many hours thereby damaging the food items.

To enable prompt actions at such time, an alarm system or temperature control system should be considered at the time of plan development.

External Alarms

This refrigeration unit is capable of delivering alarm output during abnormality (no voltage contact: contact capacity 240 V AC 3A).

During unit abnormality, the alarm output between the control terminals 9 and 10 is turned ON (continuity between the contacts). Connection of an external alarm circuit (local wiring) is recommended. External alarm power should be furnished separately from the refrigeration unit power.

Detail of abnormality alarm content is shown in the table below.

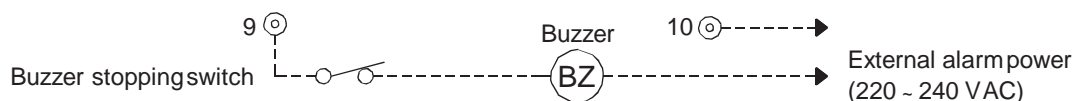

About Alarms

Description of Abnormality Alarm

When the ground fault protector is activated, check insulation of the equipment and circuit, eliminate the cause, and then supply power again.

Abnormality item	Alarm indication		External Alarms	Compressor during abnormality Operate/Stop	Reset method
	Red LED	Error code			
High pressure abnormal (7th time), or High pressure switch activated	●	E01	Yes	Stop	Operate either ground fault protector, operation switch, or controller.
Discharge gas temperature abnormal (3rd time)	●	E03	Yes	Stop	
Discharge gas temp sensor abnormal	●	E04	Yes	Stop	
Low pressure sensor abnormal	●	E05	Yes	Stop	
High pressure sensor abnormal	●	E06	Yes	Stop	
Suction gas temp sensor abnormal	○	E07	No	Operation	
Discharge gas temp abnormal (1st to 2nd time)	○	E10	No	"Auto Recovery" when the discharge temp gets 75 °C or below	Auto recovery
Inverter communication abnormal	●	E18	Yes	Stop	Operate either ground fault protector, operation switch, or controller.
Controller communication abnormal	○	E19	No	Operation	
Ambient temp sensor abnormal	●	E23	Yes	Stop	Operate either ground fault protector, operation switch, or controller.
Gas cooler fan motor abnormal (1st to 9th time)	○	E27	No	Stop for 60 sec and then "Auto Recovery"	Auto recovery
Gas cooler fan motor abnormal (10th time)	●	E28	Yes	Stop	Operate either ground fault protector, operation switch, or controller.
High pressure abnormal (1st to 6th time)	○	E31	No	Stop for 5 min and then "Auto Recovery"	Auto recovery
Refrigerant flood back alarm	○	E32	No	"Auto Recovery" when the difference between evaporating temperature and suction gas temperature is 5 K or over.	
Unit outlet temp sensor abnormal	●	E57	Yes	Stop	Operate either ground fault protector, operation switch, or controller.
Gas cooler outlet temp sensor abnormal	●	E59	Yes	Stop	
Inverter abnormal (1st to 9th time)	○	E60	No	Stop for 60 sec and then "Auto Recovery"	Auto recovery
Inverter over current (1st to 9th time)	○	E62	No	Stop for 60 sec and then "Auto Recovery"	
Inverter overload (1st to 9th time)	○	E64	No	Stop for 60 sec and then "Auto Recovery"	
Inverter step out (1st to 9th time)	○	E66	No	Stop for 60 sec and then "Auto Recovery"	
PFC abnormal (1st to 9th time)	○	E68	No	Stop for 60 sec and then "Auto Recovery"	
Inverter abnormal (10th time)	●	E70	Yes	Stop	Operate either ground fault protector, operation switch, or controller.
Inverter over current (10th time)	●	E72	Yes	Stop	
Inverter overload (10th time)	●	E74	Yes	Stop	
Inverter step out (10th time)	●	E76	Yes	Stop	
PFC abnormal (10th time)	●	E78	Yes	Stop	
Split cycle outlet temp sensor abnormal	●	E80	Yes	Stop	
Intermediate pressure sensor abnormal	●	E81	Yes	Stop	
Refrigerant insufficient	○	E82	No	"Auto Recovery" when the opening of split cycle electronic expansion valve is 175 (steps) or below.	Auto recovery

● indicates lighting up, and ○ indicates blinking.

Red blinking LED is maintained even after auto-recovery of alarm content. Check the content by Alarm history.
Method of clearing Red LED: After correcting the abnormality content, align the rotary switch (knob) with [OPERATION] and press ▲ button.

Maintenance and Inspection

Maintenance and inspection should be contacted with a specialty company.

Request for Maintenance and Inspection (To a specialty company for installation work)

The structural components of refrigeration unit do not last permanently but include those wearing out in a certain period of time.

In order to prevent accidents before they occur, those components need to be inspected periodically before reaching their service life and replaced.

Installation company needs to contract with the equipment user for performing scheduled inspection of the equipment including the cooling system.

Service Parts and Replacement Guidelines

Major components requiring inspection and replacement in a refrigeration unit along with their frequency of inspection and replacement are shown below. When any abnormality is detected by inspection, replace it early. As to the engineering detail for inspection and replacement, refer to the "Refrigeration Unit Handbook" and "Engineering Service Manual" issued by our company.

Inspection and replacement timing vary by operation rate and condition, ambient environment, and individual component condition and cannot uniformly be determined. We request you to perform full inspection particularly at (1) Commissioning, (2) Scheduled inspection, (3) System maintenance, etc.

Inspection items/Replacement parts		Inspection content/Replacement guideline
System overall (Each part temperature)		(1) Pressure condition should match the cooling temperature (2) Temperature of each part must be normal (3) No abnormality exists in the installed condition.
Compressor	Abnormal sound, abnormal vibration	No abnormal sound or abnormal vibration should be generated.
Gas cooler	Fin clogging	Is the fin clogged with dust ? ... Scheduled cleaning
	Fan rotation	Is there any abnormality in the fan rotation ?
Piping component	Filter dryer	Replace the filter dryer for clogging, deformation, or large temperature and/or large pressure differences between the dryer inlet and outlet.
	Suction filter	Replace the Suction filter for clogging, deformation, or large temperature and/or large pressure differences (abnormally low pressure) between the filter inlet and outlet.
	Other piping positions	Refrigerant leak, oil leak, deformation, abnormal vibration, deterioration of heat insulation material
Electrical components	Fan motor	Replace when generating abnormal sound, heavy in rotation, oil smearing, etc.
	Activation of protection device and control component	Replace when control failure by motion defect, chattering etc.
	Terminal, wiring, etc.	Any change of color, deterioration of insulation

Actions at the time of Failure

When a component failure or malfunction is found, request the specialty company to repair.

Actions at the time of Failure

When the refrigeration unit or any refrigerant circuit component fails to operate by some reason, turn off the power for a repair.

To avoid failure recurrence, use caution for the following.

- (1) To avoid recurrence of the same failure, execute reliable failure diagnosis and identify the true cause before starting a repair.
When the ground fault protector is activated, check insulation of the equipment and circuit, eliminate the cause, and then supply power gain.
- (2) When the piping is to be corrected, be sure to release refrigerant from the welded point, and perform welding while flowing nitrogen gas.
- (3) When replacing the major component such as compressor, gas cooler, or refrigerant and oil, always replace the filter dryer.
When the refrigerant circuit is contaminated by burnt compressor motor, etc. apply nitrogen blow to eliminate refrigeration oil remaining in the refrigerant circuit.
(At such time, also remove the expansion valve (electronic expansion valve))
- (4) When replacing the compressor, do not apply power to the crankcase heater while it is removed from the compressor. Be sure to shut off the power. (It may lead to fire)
- (5) To avoid current leak accident, install the components (cover, electric parts, etc.) removed during inspection and service and attach them as they were originally.
- (6) When replacing the fuse, be sure to use the company-specified fuse with silica sand.
(Commercial product may rupture when the fuse blows out)
- (7) When the digital display (LED) on the control PCB does not operate with the power supplied, check the following.

Caution Always check after shutting off the power.

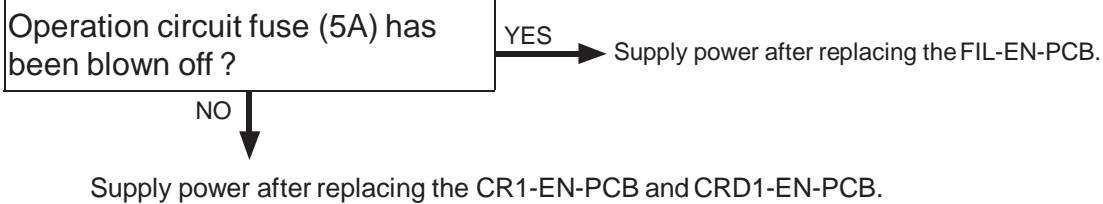

When the failure cause is unknown, contact our service office with the failure symptom, model number, manufacturing code, etc.

Actions at the time of Failure

Replacing the Compressor

Before replacing the compressor, refer to the Engineering Service Manual "Compressor Replacement Procedure"

Caution

- (1) Be sure to shut off the ground fault protector. (Operation switch OFF does not shut off the crankcase heater.)
- (2) Connect compressor terminals U, V, and W with each lead wire as connected before. (For avoiding phase inversion)
U —Red, V —White, W —Blue
- (3) Install the crankcase heater at the specified position tightly contacting the compressor.
- (4) Apply evacuation from both the high pressure and low pressure service valves.

Method of Clearing Alarm History

Operate the rotary switch (knob) and DIP switch.

- (1) Align the rotary switch (knob) with [DIS]. (Discharge gas temperature is displayed)
- (2) Turn ON the DIP switch SW13-7.
- (3) Press ▼ button. (Entire content of [Alarm History] is cleared.)
- (4) Turn OFF the DIP switch SW13-7.
- (5) Align the rotary switch (knob) with [Alarm History] and confirm that [E - - -] is displayed, indicating that the content has been cleared.
- (6) Set the rotary switch (knob) back to [OPERATION] position.

Failure Diagnosis

Error Code

(1) When the rotary switch (knob) is at [OPERATION] position, the digital display on the control PCB alternately displays low pressure, high pressure and error code (E ***).

< Error Code Table >

Error code	Meaning	Cause	Method of Action (Listed)
E01	High pressure abnormal (7th time) or High Pressure Switch Activated	High pressure increased to abnormal level.	(1) Check the cause of high pressure abnormality. (2) Check if abnormality exists in the high pressure sensor.
E03	Discharge gas temperature abnormal (3rd time)	Abnormality stopping caused by discharge gas temperature exceeding 118 °C occurred 3 times in 2 hours.	Follow the procedure shown in "Failure diagnosis of abnormal discharge gas temperature". (1) Investigate the cause of high discharge gas temperature. (2) Check the connection of "2P6 Discharge Connector" of the control PCB. (3) Check the resistance value of the discharge gas temperature sensor.
E04	Discharge gas temp sensor abnormal	Discharge gas temperature sensor became abnormal (open).	(1) Check the connection of "2P6 discharge connector" of the control PCB. (2) Check the resistance value of the discharge gas temperature sensor.
E05	Low pressure sensor abnormal	Low pressure sensor became abnormal (open).	(1) Check the connection of "3P1 low pressure connector" of the control PCB. (2) Check the output voltage of the low pressure sensor.
E06	High pressure sensor abnormal	High pressure sensor became abnormal (open).	(1) Check the connection of "3P3 high pressure connector" of the control PCB. (2) Check the output voltage of the high pressure sensor.
E07	Suction gas temp sensor abnormal	Suction gas temperature sensor became abnormal (open).	(1) Check the connection of "2P5U inlet connector" of the control PCB. (2) Check the resistance value of the suction gas temperature sensor.
E10	Discharge gas temperature abnormal (1st to 2nd time)	Discharge gas temperature exceeded 118 °C and caused abnormality stop. Or discharge temp sensor shorted.	Follow the procedure shown in "Failure diagnosis of abnormal discharge gas temperature". (1) Investigate the cause of high discharge gas temperature. (2) Check the connection of "2P6 discharge connector" of the control PCB. (3) Check the resistance value of the discharge gas temperature sensor.
E18	Inverter communication abnormal	No serial communication signals between "Control PCB" and "Inverter-PCB".	Check the communication line between "2P11INV connector" of the control PCB and "CN14 connector" of the inverter-PCB.
E19	Communication abnormal	No controller signal exists in communication.	(1) Check the communication line ("5P2, 5P3 connector" of the control PCB) (2) Set the communication refrigeration machine No. other than "0".
E23	Ambient temp sensor abnormal	Ambient temperature sensor became abnormal (open).	(1) Check the connection of "2P1 ambient connector" of the control PCB. (2) Check the resistance value of the ambient temperature sensor.
E27	Gas cooler fan motor abnormal (1st to 9th time)	Gas cooler fan motor became abnormal. (Fan rotation speed largely deviated from the command rotation speed.)	(1) Check fan locked or dismantled. (2) Check connection of "CN007 connector" of the inverter-PCB.
E28	Gas cooler fan motor abnormal (10th time)	Gas cooler fan motor became abnormal. (Fan rotation speed largely deviated from the command rotation speed.)	(1) Check fan locked or dismantled. (2) Check connection of "CN007 connector" of the inverter-PCB.

Failure Diagnosis

Error Code

Error code	Meaning	Cause	Method of Action (Listed)
E31	High pressure abnormal (1st to 6th time)	High pressure increased to abnormal level.	(1) Check the cause of high pressure abnormality. (2) Check if abnormality exists in the high pressure sensor.
E32	Refrigerant flood back alarm	Suction gas superheat (difference between the "suction gas temperature" and "evaporating temperature converted from low pressure") became 1 K or below continuously for 2 minutes.	Check the cause of refrigerant flood back operation.
E57	Unit outlet temp sensor abnormal	Unit outlet temp sensor became abnormal (open condition).	(1) Check the connection of "2P4 U outlet connector" of the control PCB. (2) Check the resistance value of the unit outlet temperature sensor.
E59	Gas cooler outlet temp sensor abnormal	Gas cooler outlet temp sensor became abnormal (open)	(1) Check the connection of "2P3 GC outlet connector" of the control PCB. (2) Check the resistance value of the gas cooler outlet temperature sensor.
E60	Inverter abnormal (1st to 9th time)	Input Current Sensor Fault EEPROM Data Fault	See "E70"
E62	Inverter Over Current (1st to 9th time)	Over Current (Inverter Output Current)	See "E72"
E64	Inverter Over Load (1st to 9th time)	Over Current (Inverter Input Current)	See "E74"
E66	Inverter Step Out (1st to 9th time)	Step Out	See "E76"
E68	PFC abnormal (1st to 9th time)	PFC circuit Fault	See "E78"
E70	Inverter abnormal (10th time)	Input Current Sensor Fault EEPROM Data Fault	(1) Check the connection to the inverter PCB. (2) Check whether abnormality occurred in the power supply. (3) Replace the inverter PCB
E72	Inverter Over Current (10th time)	Over Current (Inverter Output Current)	(1) Check the cause of overload operation. (2) Check the connection line between the inverter PCB and the compressor. (3) Check whether abnormality occurred in the power supply. (4) Replace the inverter PCB.
E74	Inverter Over Load (10th time)	Over Current (Inverter Input Current)	(1) Check the cause of overload operation. (2) Check the connection line between the inverter PCB and the compressor. (3) Check the connection the Power supply. (4) Check whether abnormality occurred in the power supply. (5) Replace the inverter PCB.
E76	Inverter Step Out (10th time)	Inverter Step Out	(1) Check short cycle operation (frequent start/stop operation). (2) Check the connection line between the inverter PCB and the compressor. (3) Check the connection the Power supply. (4) Check whether abnormality occurred in the power supply. (5) Replace the inverter PCB.
E78	PFC abnormal (10th time)	PFC circuit Fault	(1) Check the connection the Power supply. (2) Check whether abnormality occurred in the power supply. (3) Replace the inverter PCB.
E80	Split cycle outlet temp sensor abnormal	Split cycle outlet temp sensor became abnormal (open)	(1) Check the connection of "2P2 S outlet connector" of the control PCB. (2) Check the resistance value of the split outlet temperature sensor.
E81	Intermediate pressure sensor abnormal	Intermediate pressure sensor became abnormal (open).	(1) Check the connection of "3P2 intermediate pressure connector" of the control PCB. (2) Check the resistance value of the intermediate pressure sensor.
E82	Refrigerant insufficient		

Failure Diagnosis

(2) Other indications

Indication	Meaning	Action method	Remarks
Alarm (red) LED blinking	Abnormality existed before. Up to 50 items of past error codes are memorized in the "Alarm History".	Check the error code with the table above and eliminate the cause. Then, by aligning the rotary switch knob with [OPERATION] and pressing ▲ button or turning OFF the operation switch clears the LED blinking.	
Digital display [-CH-]	Check mode.	Set the Slide switch SW15 of the CRD1-EN- PCB to [CONTROL].	

Failure Diagnosis at the time of Abnormal Discharge Gas Temperature

When the discharge gas temperature goes up abnormally, compressor is stopped for protecting the compression components of the compressor and discharge gas temperature abnormality alarm is generated at the same time. In such a case, check the problem position and apply appropriate actions in the sequence shown below.

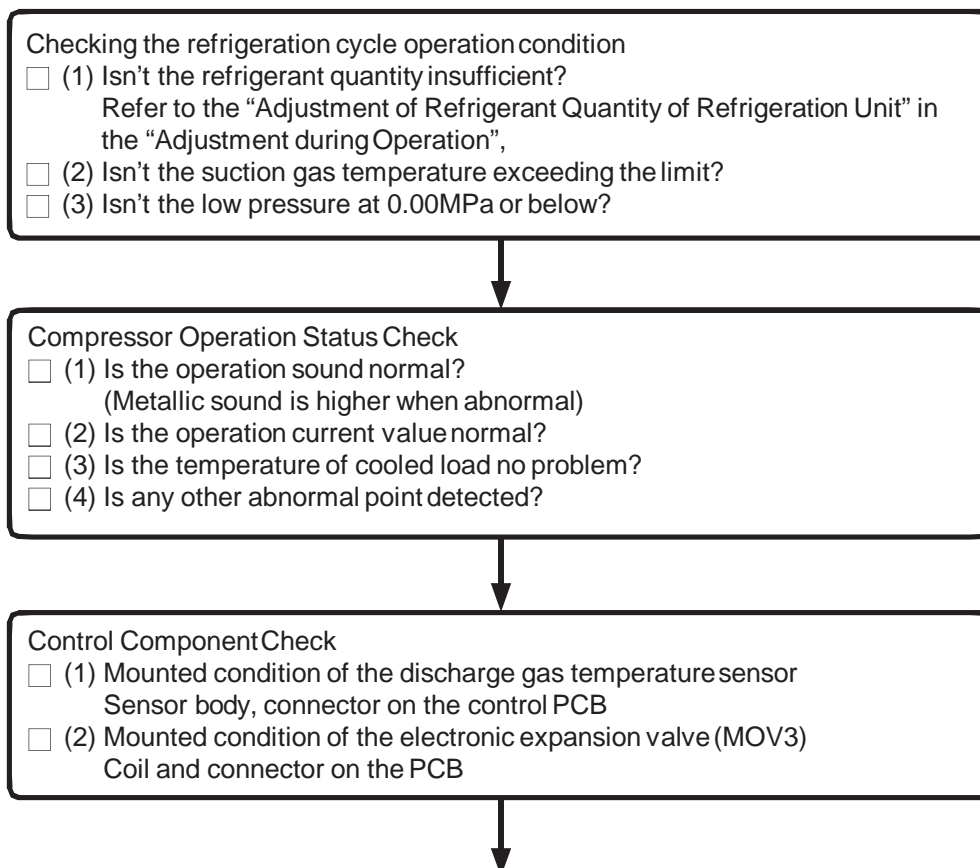

(To be continued)

Failure Diagnosis

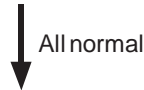

Electronic expansion valve (MOV3) Operation Check

- (1) Align the rotary switch (knob) with [DIS] and check the discharge gas temperature of the compressor.
- (2) Set the DIP switch SW13-5 to [ON], and rotary switch (knob) to [ON] (valve opening fixed mode) and set the electronic expansion valve opening to 450 steps.

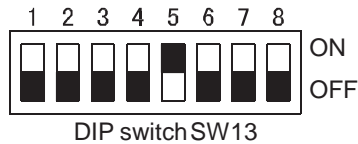

At this time, check that discharge gas temperature slowly goes down.

Caution

Before checking the electronic expansion valve operation, if the valve has been operating with a full opening (480 steps), discharge gas temperature does not change. Wait for some time and then check.

If the electronic expansion valve is fully open, then refrigerant pipe clogging is the possible cause.

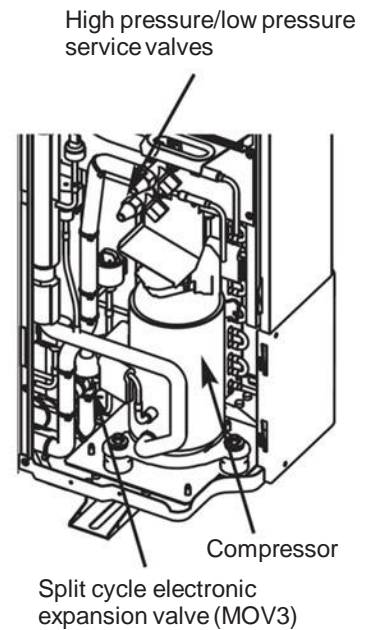

Failure Diagnosis of Gas Cooler Fan

(1) When the ground fault protector shuts OFF.

1. Check the insulation resistance between each terminal of the power supply unit, fan motor inverter-PCB (hereafter, inverter-PCB) and the ground (G terminal).
..... When the insulation resistance is 1 M Ω or below, insulation failure exists in the inverter-PCB or fan motor.
2. Disconnect the fan motor lead wire from the inverter-PCB and check the insulation resistance between the ground.
..... When the insulation resistance is 1 M Ω or below, insulation failure exists in the fan motor.

(2) When the fan motor does not rotate normally.

1. While the fan motor is powered, it does not rotate smoothly (stopping or uneven rotation) or generates roaring noise.
..... Fan motor bearing failure is the cause.

Failure Diagnosis

Method of Checking Sensor Characteristics

(1) Pressure (Low, Intermediate, High pressure) sensor

While the connector is inserted to the control PCB, measure the voltage and check if the pressure is normal by using the table below.

< Relationship between sensor output voltage and pressure >

Pressure (MPa)	0.00	1.00	2.00	3.00	4.00	5.00	6.00	7.00	8.00	9.00	10.00	11.00	12.00
Voltage (DCV)	0.50	0.77	1.03	1.30	1.57	1.83	2.10	2.37	2.63	2.90	3.17	3.43	3.70

* In the table above, when the pressure value is an intermediate value such as 4.5MPa, use a proportional calculation.

Caution

When checking the voltage of a pressure sensor, always use DVC range of the tester. Use caution, measurement by using resistance range may cause a sensor failure.

[Voltage measurement method]

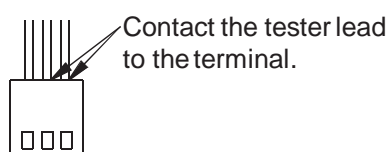

[CR1-EN-PCB] Red lead (+) of the tester
Black lead (-) of the tester

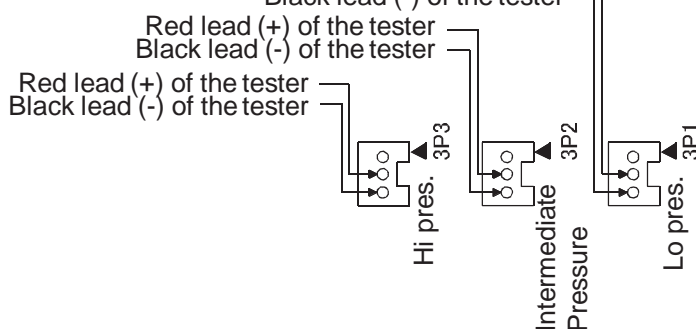

(2) Suction gas temperaturesensor

Measure the resistance while the connector is disconnected from the control PCB, and check if the temperature is normal by using the following table.

< Relationship between sensor temperature and resistance value >

Temperature (°C)	-50	-40	-30	-20	-10	0	10	20	30
Resistance value (kΩ)	77.58	43.34	25.17	15.13	9.39	6.00	3.94	2.64	1.82

* In the table above, when the temperature is an intermediate value such as -5 °C, use a proportional calculation.

[Resistance measurement method]

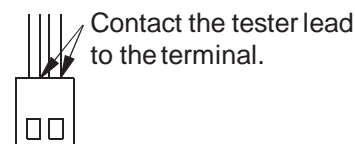

(3) Discharge gas temperaturesensor

Measure the resistance while the connector is disconnected from the control PCB, and check if the temperature is normal by using the following table.

< Relationship between sensor temperature and resistance value >

Temperature (°C)	20	30	40	50	60	70	80	90	100	110	120
Resistance value (kΩ)	70.13	45.05	29.67	20.00	13.79	9.71	6.97	5.09	3.77	2.84	2.16

* In the table above, when the temperature is an intermediate value such as 65 °C, use a proportional calculation.

(4) Other temperature (unit outlet, split cycle outlet, gas cooler outlet, ambient temperature.) sensors

Measure the resistance while the connector is disconnected from the control PCB, and check if the temperature is normal by using the following table.

< Relationship between sensor temperature and resistance value >

Temperature (°C)	-10	0	10	20	30	40	50	60	70
Resistance value (kΩ)	26.22	15.76	9.76	6.21	4.05	2.70	1.84	1.28	0.90

* In the table above, when the temperature is an intermediate value such as 35 °C, use a proportional calculation.

Failure Diagnosis

Method of Checking the Resistance of Electronic Expansion Valve Coil

■ Electronic expansion valve coil:

(Split cycle electronic expansion valve MOV3 and Adjusting refrigerant amount electronic expansion valve MOV4)

Measure the resistance value by disconnecting the connector from the control PCB, and check if the resistance value is normal.

Caution

Control PCB will fail when the refrigerator power is supplied while the coil resistance is 0 Ω (shorted). When a motion failure of an electronic expansion valve is questioned, always check the resistance value of the electronic expansion valve before replacing the control PCB.

Measurement Position	Resistance Value
Between connector 1-6	185 Ω ± 18 Ω
Between connector 2-6	185 Ω ± 18 Ω
Between connector 3-6	185 Ω ± 18 Ω
Between connector 4-6	185 Ω ± 18 Ω

(Ambient temperature: 20°C)

[Resistance measurement method]

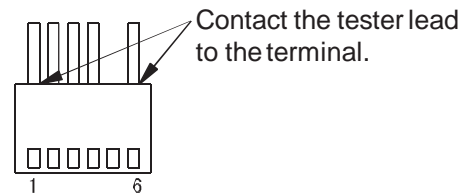

< Electronic expansion valve wiring connector >
 6P1: Split cycle electronic expansion valve (MOV3)
 6P2: Adjusting refrigerant amount
 electronic expansion valve (MOV4)

Failure Diagnosis

Failure Diagnosis of Inverter Unit

Caution

Before inspection or component replacement, always shut off the ground fault protector and take sufficient time.

(Approx. 5 minutes are required for the capacitor to discharge)

Electrical box internal layout

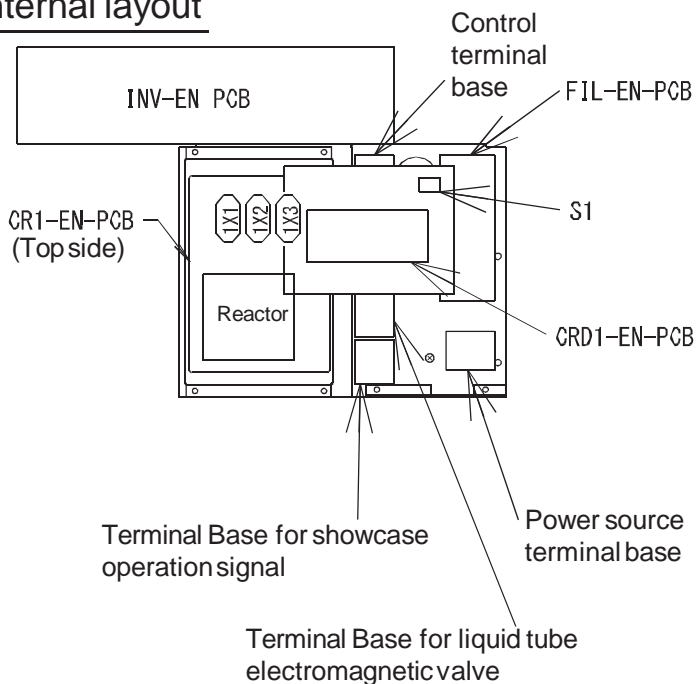

(1) When the refrigeration unit stopped by activation of the ground fault protector, possible cause is as follows. Check all of the following causes.

Cause	Method of Checking	Method of Action
Compressor failure	Check insulation resistance between each phase of compressor and case. Less than 1 MΩ indicates motor failure.	Replace the compressor
	Check the winding resistance of the compressor. 0.97 Ω to 1.01 Ω (AT 25 °C) indicates no problem.	Replace the compressor
Failure of an electric component other than compressor	Check the insulation resistance between each terminal of the INV-EN-PCB and ground (G terminal). Less than 1 MΩ indicates insulation failure of the INV-EN-PCB.	Replace the INV-EN-PCB

Caution

Be sure to eliminate the cause of the failure before supplying the power (turning the ground fault protector ON).

Failure Diagnosis

Failure Diagnosis of Inverter Unit

(2) When inverter abnormality (E6 * to E7 *) is generated
Possible cause is as follows. Check all of the following causes.

Cause	Method of Checking	Method of Action
Overload condition	(1) Check if the compressor motor current is high. (2) Check if any overload condition occurred even in a short duration of time.	Eliminate the cause of overload.
Abnormality of power voltage	Check if the supplied power voltage to the refrigeration unit is in the range of 220 V \pm 22 V / 230 V \pm 23 V / 240 V \pm 24 V.	Execute maintenance of the power supply facility.
Failure of the INV-EN-PCB	When the supplied voltage to the refrigeration unit is in the range of 220V \pm 22 V / 230V \pm 23 V / 240 V \pm 24 V, check if any abnormality exists in the appearance or component chipping of the INV-EN-PCB.	Replace the INV-EN-PCB.
	(1) Check if any difference exists between the motor current of the compressor and the current value displayed on the CRD1-EN-PCB. (2) No problem if the difference in current value is \pm 10 % .	Replace the INV-EN-PCB.

Caution

When an external cause such as momentary power failure or lightening, or short duration of overload occurs, an error is generated by momentary overcurrent even without any component failure.

– NOTE –

When an accident or damage is caused by applying an installation method not described in this manual or not using the specified component, our company will not assume responsibility. If a product failure occurs by incorrect installation, the product becomes out of warranty.

Documentation in local language can be downloaded from Internet Panasonic pro club.

Download site: www.panasonicproclub.com

Panasonic Corporation
Website: www.panasonic-europe.com

Sales company in EU
Panasonic Appliances Air Conditioning Europe
(PAPAEU)
Panasonic Marketing Europe GmbH
Hagenauer Str. 43 - 65203 Wiesbaden, Germany

Printed in Japan

Authorized representative in EU
Panasonic Testing Centre
Panasonic Marketing Europe GmbH
Winsbergring 15, 22525 Hamburg, Germany

D0517-0

80264179396000
