

DAIRY

MPD218

MULTIDECK DOOR MEDIUM TEMPERATURE CABINET



ENHANCED ENERGY EFFICIENCY
& VERSATILITY

HUSSmann®

*Image shown with fully frameless doors

PRODUCT BENEFITS

- Ergonomic design for easy access
- Alternative shelving layouts to optimise merchandising
- Optimised display with LED lighting
- Low Total Energy Consumption (TEC)
- Longer merchandise shelf life
- Product temperature compliance
- Simple to install and maintain
- Designed for modular configurations

STANDARD FEATURES

- Internal and external powder coating
- Single row of 4000K LED canopy lighting
- Vertical 4000K mullion LED lights
- 5 rows of 500mm powder coated shelves
- Ticket strips
- Galvanised base
- Rubber bumper
- Evaporator assembly fitted with valve
- EC fan motors
- Digital thermometer display fitted
- Alarm probe fitted with conduit and draw wire
- Standard doors and handles

CUSTOMISATIONS

Shelving & Base Shelf

- Additional shelves and brackets
- Stainless steel reinforced shelving and base tray
- Hang sell and bar
- Wire or acrylic shelf fences (45mm, 75mm)
- Adjustable wire base rack with product stop

Lighting

- Undershelf lighting
- Standard lighting (3000K, 3300K, 4000K)
- Premium lighting available

Ends

- Solid mirror end / Glass view end
- Common end
- Acrylic full height system divider

Bumper

- Stainless steel bumper (single or double rail)

Other

- Fully Frameless Doors (as shown in render)
- Rear mirror kit
- Top mount piping
- Rear dress panels

- Valance panels - top or lower rear
- Stainless steel base liner
- Technology solutions

- Electronic shelf labels or video rail

Energy & Sustainability

- Ambient Fan Kit

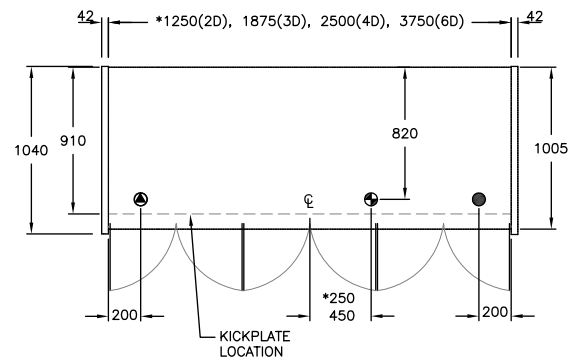
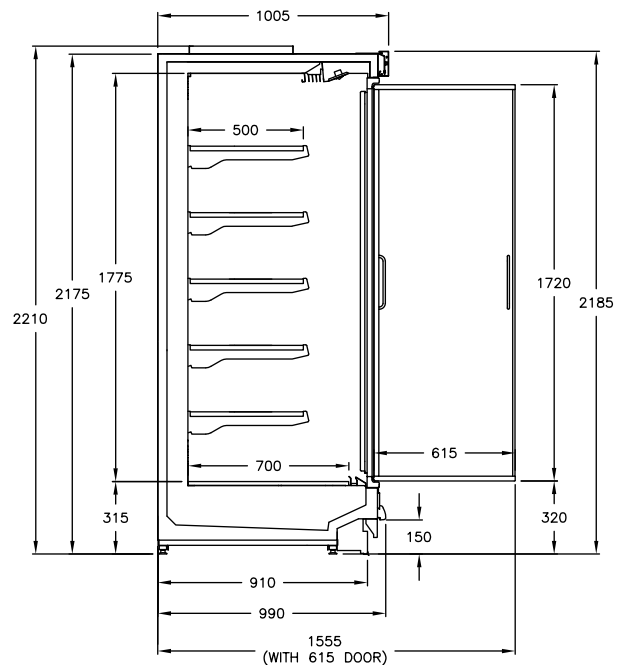

AVAILABLE LENGTHS

Excluding Ends: 1250, 1875, 2500, 3750
Crown Ends: 1875, 2115

AVAILABLE DEPTHS

MPD118 - Narrow: 890
MPD218 - Standard: 990
MPD318 - Deep: 1090

TEMPERATURE CLASS
3M1
(-1 °C to +5 °C)

AVAILABLE COLOURS



Additional Information

All Dimensions shown in Millimetres (mm) unless otherwise stated. Dimensions and features are subject to change. Please obtain current technical information prior to order confirmation.

NOTE: We reserve the right to change or revise specifications and product design in connection with any feature of our products. Such changes do not entitle the buyer to corresponding changes, improvements, additions or replacements for equipment previously sold or Shipped.

